



RACKING-UK

Storage & Workplace Equipment



essexmezz@icloud.com



www.racking-uk.com



01621 786 630



07831 653839

Racking UK, 39 High Street, Burnham-on-Crouch, Essex, CM0 8AG

Contents

Rivet Racking	<p>4 Shelving Guide</p> <p>6 Clicka Shelving Intro 7 Clicka Kits</p> <p>8 Kwikrack Intro 11 Kwikrack Bays</p> <p>12 Rivet Racking Intro 14 Technical Guide 16 Heavy & Medium Rivet 22 Solid Steel Decking 23 Wire Mesh Decking 24 J Rivet 26 Rivet Divider System 27 Heavy Rivet MFC 29 Rivet Shelf Bins & Kits 32 Rivet Cable Reel Racks 31 Rivet Garment Racks 32 Rivet Archive 36 Work Benches & Stations</p> <p>44 EXPO 4 Intro 46 Expo 4G 47 Expo 4 48 Expo Cladding 50 Expo 4D 52 Expo 3</p> <p>56 Delta Plus Intro 58 Open Bays & Cladding 59 Delta Accessories</p> <p>60 Midspan Intro 62 Technical Guide 64 Automotive Solutions 66 Frames & Levels</p> <p>66 TS Longspan Intro 68 Technical Guide 70 Frames & Levels 71 Chipboard Decking Bays 72 Solid Steel Decking Bays 73 Steel Wire Mesh Decking Bays 74 Divider System 75 Shelf Bins 76 Automotive Solutions 77 Garment Solution</p> <p>78 Cantilever Rack Intro 79 Cantilever Bays</p> <p>80 Vertical Rack Intro 81 Vertical Bays</p> <p>82 Pallet Racking Intro 84 Technical Guide 85 Frames, Beams & Accessories 86 Decking, Spacers & Support Bars 87 Pallet Racking Kits</p> <p>88 Rack Armour® Intro 90 Rack Armour® Upright Protectors 91 Rack Protection Barriers</p>
Steel Shelving	<p>92 Rhino Bins Intro 93 Rhino Bins Range 94 Louvre Panels 95 Rhino Bins 96 Rhino Bins on Louvre Panels 100 Rhino Bins on Louvre Racks 102 Rhino Bins on Louvre Trolleys 104 Rhino Bins in Bays</p> <p>106 Component Organisers Intro 107 Component Organiser Kits</p> <p>108 Tilt Bins Intro 109 Tilt Bins Kits 110 Tilt Bins on Louvre Trolleys 111 Tilt Bins on Louvre Racks 112 Tilt Bins Frames & Stands 113 Tilt Bins Frames & Stand Kits</p> <p>116 Shelf Trays Intro 118 Shelf Trays on Racks 119 Shelf Trays</p> <p>120 Kanban Shelving 129 Kanban with Bins & Shelf Trays</p> <p>122 Shelf Bins Intro 124 Delta with Shelf Bins 125 Rivet with Shelf Bins</p> <p>126 Labelling Solutions 127 Magnetic Racking Strips & Labels 128 Racksack, Racksack Mini & Racksack Nano 129 Graphic Floor Signs & ID Frames</p> <p>130 Heavy Duty Bollards</p> <p>131 Bumper Barriers</p> <p>133 Bollards, Rails & Gates</p> <p>136 Column Protectors & Spacesavers</p> <p>137 Sign & Lamp Post Wraps</p> <p>138 Projects, Training & Inspections</p>
Long & Bulky Storage	

Plastic Storage, Bins & Labelling

Terms & Conditions

Important

All racking systems are supplied flat packed for assembly on site. Weights and loadings are based on **UDL** (uniformly distributed loads).

If the height to depth ratio is more than 4:1 then the racking should be secured to the floor or wall.

Prices

All quoted prices are exclusive of VAT at the prevailing rate and are subject to change. Errors and omissions excepted (E&OE).

Delivery

All prices are inclusive of delivery to the areas indicated in the schedule below. All orders under **£200** are subject to a **£25 small order charge**. Goods shall be delivered within 5 days from payment, if available from stock.

Delivery will be to kerbside and heavy items may require fork lift unloading and/or assistance on site.

Delivery is to a business address **Monday to Friday 8.30am to 5.00pm**. Restricted delivery areas or residential addresses may incur a surcharge.



Delivery Zones

Area	5 Day	Next Day
Mainland England and Wales	FREE	P.O.A
Scotland (Only TD, DG, EH, ML, KA, KY, G)	+ £25.00	P.O.A
Rest of Scotland (FK, PA, DD, PH, AB, IV, KW,HS)	P.O.A	P.O.A
All islands	P.O.A	P.O.A

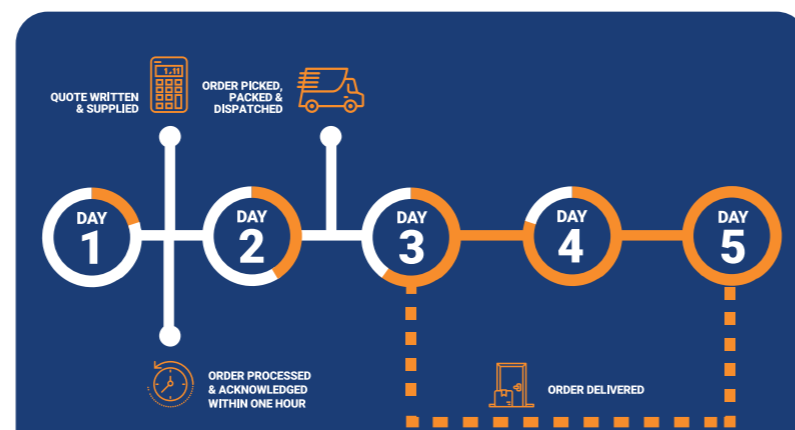

Automotive Solutions



TS Longspan Tyre Rack p.76

Midspan Automotive Solutions p.64

Impact Protection



Rack Armour® p.88

Brandsafe Impact Protection p.130

Office & Filing



Delta Plus p.56

Clicka p.6

Garment Storage



Rivet Garment Racks p.31

Longspan Garment Solution p.77

Labelling & Accessories



Warehouse Labelling p.127

racksack® waste sorting sack p.128



Archiving



Rivet Racking Archive p.34

Clicka Archive p.6

Workshop or Factory



Workbenches & Workstations p.32

Small Parts Picking



Rhino Plastic Bins p.92

Shelf Trays p.116

Quickly find the shelving system you need

Quick Shelving Guide (Only shelving and racking products are included in this guide)

Page	Product	Max Loading Capacity (UDL)		Max Height (mm)	Max Width (mm)	Max Depth (mm)	Most suitable for				
		Shelf	Bay / Frame*				Warehouse	Storeroom	Workshop	Office	Garage
6	Clicka 265	265kg	1325kg	1770	1200	600		✓		✓	✓
6	Clicka Galvanised	265kg	1325kg	1980	1200	600	✓	✓	✓	✓	✓
8	Kwikrack	300kg	1500kg	2500	1500	600	✓	✓	✓		✓
16	Medium Rivet	300kg	2800kg	3660	1830	1220	✓	✓	✓		
16	Heavy Rivet	600kg	2800kg	3660	2440	1220	✓	✓	✓		
24	J Rivet	150kg	2800kg	3660	1220	610	✓	✓	✓		
38	Rivet Workstation	400kg	600kg	1830	2440	915	✓	✓	✓		
40	Rivet Workbench	400kg	600kg	915	2440	915	✓	✓	✓		
42	Rivet Mobile Workbench	300kg	300kg	880	1830	915	✓	✓	✓		
44	Rivet Packing Bench/Workstation	300kg	300kg	1830	1830	1830	✓	✓	✓		
46	EXPO 4G	200kg	2500kg	7000	1150	600	✓		✓	✓	
47	EXPO 4	200kg	2500kg	7000	1150	600	✓		✓	✓	
50	EXPO 4D	200kg	2500kg	7000	1150	600	✓		✓	✓	
52	EXPO 3	300kg	2500kg	7000	1300	800	✓	✓	✓		
56	Delta Plus	120kg	600kg	2530	986	600		✓		✓	
60	Midispan	750kg	8800kg	6000	2400	1200	✓	✓	✓		
66	TS Longspan	950kg	3900kg	4016	2754	1233	✓	✓			
78	Cantilever	600kg	2200kg	2964	1500	2180*	✓	✓	✓		
80	Vertical Racking	Variable	Variable	2550	1800	810*	✓	✓	✓		
82	Pallet Racking	3790kg	11000kg	6000*	3300*	1100*	✓				
120	Kanban Shelving	80kg	400kg	1830	915	610	✓	✓	✓		✓

■ Heavy Duty
 ■ Medium Duty
 ■ Light Duty
 *See product specific page for more info
 Suitability shown is a suggestion only, the use of the products is not limited by the applications specified in this table.

How to find the best storage solution

The storage environment.

We have tried to make selecting the right system storage system simple and easy. With clear and intuitive icons on each page, it's easy to make a quick selection. Need more information? No problem. Highly detailed technical information is available for each product.

Our application icons quickly and simply indicate the environment the system is most suitable for. Application can range from the office to retail to the warehouse. Most of our products are suitable for multiple environments - this is illustrated by the icons shown below.



Please note the usage indicated is only a suggestion and doesn't limit the use of the product in different environments

What exactly do you need to store?

For most workplaces there is generally a wide variety of products that come in a wide range of sizes and loading capacities. It is important to have a clear specification of the weight and dimensions of the goods, this will give a clear understanding as to the type of shelving required.

From this information you will be able to establish the shelf and total bay capacity needed, the overall size of the shelf required to store the various items.



Note

Capacities stated on the icons are based on maximum uniformly distributed loads (UDL). The total bay load is dependent on several factors such as shelf pitch (distance between levels), height of the first shelf & actual size of the shelves.

The meaning of the colours:

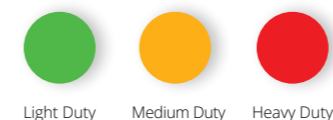

Find your solutions.

In addition to our key application and loading icons, we illustrate further information using the icons shown below. You will find these icons at the start of each major product section.

The icons below illustrate dimensions (Height, Width, Depth), application, construction as well as more detailed loading information. The information you'll find below each of these icons act as a summary for the product section that follows, saving you time when you're finding the perfect storage solution.



From left to right these icons illustrate - height, width, depth, application, construction and loading

Guarantee

All of our products come with a guarantee. You will find the relevant guarantee detailed on the first page of each product section.



Assembly Time

Assembly time is now noted on all shelving. This can range from 5 - 20 minutes, based on two competent people building a single bay.



Additional Features

Our product range is vast and extremely diverse, as a result each product has its own features and benefits. Our icons visualise some key features.



These small target icons appear under some images, in pricelists and support graphics. They link the pictured product with its actual size in the pricelist.

Clicka 265 Archive 1770 x 1200 x 450 with 15 archive boxes

5
YEAR
Guarantee

48hr
Delivery

5
MINS
Assembly

Boltless

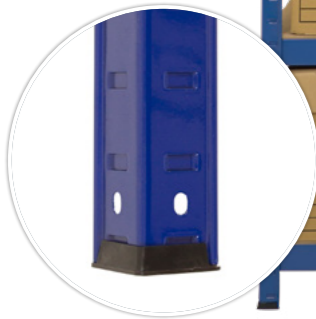

Clicka 265 with 15 Archive Boxes		
H x W x D (mm)	Code	Shelf Load (kg)
1880 x 1200 x 450	CL265E/AK15	265kgs

Archive Box 270 H x 350 W x 430 D (mm)

Each bay is delivered flat-packed. Price includes uprights, upright connectors, plastic feet, beams, shelf supports and MDF shelves. The Archive bay includes 15x flat-packed archive boxes with lids.

CLICKA SHELVING

Clicka shelving offers a solution to your storage needs, as well as your budget.

It is simple to erect yet has all the strength you are likely to require and is available in 265kg or 175kg shelf capacities. Manufactured with high quality materials and finish.

Whether you are fitting out the home or workplace, our Clicka Shelving kits offers strength and simplicity at an incredible price.

- Best value shelving system**
265kg or 175kg shelf capacity at great prices
- Superior quality and strength**
Robust and strong
- Easy to assemble and re-configure**
Build a bay in less than 10 minutes with just a rubber mallet
- Fast 48hr delivery**
There when you want it – without fail
- Will suit any application**
A versatile range, ideal for home, office, garage or storeroom

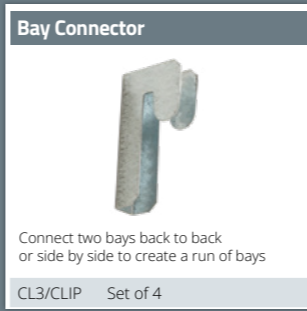

Our best value shelving – compare our quality and our prices



Available Sizes



Clicka 265 (MDF)		
H x W x D (mm)	Code	Shelf Load(kg)
1800 x 900 x 300	CL265A/BB	265kgs
1800 x 900 x 450	CL265B/BB	265kgs
1800 x 900 x 600	CL265C/BB	265kgs
1800 x 1200 x 300	CL265D/BB	265kgs
1800 x 1200 x 450	CL265E/BB	265kgs
1800 x 1200 x 600	CL265F/BB	265kgs



Clicka Galvanised (Mesh Decking)		
H x W x D (mm)	Code	Shelf Load(kg)
1980 x 1200 x 600	RB350M	265kgs

Each bay is delivered flat-packed. Price includes uprights, upright connectors, plastic feet, beams, desk supports and shelves

265
KG
Shelf Load

1325
KG
Bay Load

Heights

Clicka 265
1770mm

Uprights come split into two – allowing the system to be packed flat and used as two benches if required.

Clicka 175
1800mm

Clicka Galvanised
1980mm

Widths

Clicka 265
900mm, 1200 mm

Clicka 175
900mm

Clicka Galvanised
1200mm

Depths

Clicka 265 depths
300mm, 450mm, 600mm

Clicka 175
450mm, 600mm

Clicka Galvanised
600mm

Application

Environment
Garage, Storeroom or Office

Usage
General Shelving, Archive, Workbench

Construction

Split Uprights: **Steel**
Blue RAL5002

Beams: **Steel**
Blue RAL5002

Clicka 265 & 175
5 x MDF Shelves

Clicka Galvanised RB350M
Mesh Decking

Loadings

Clicka 265 Max Bay Load
1325kg

Clicka 265 Shelf Load
up to **265kg** UDL

Clicka 175 Shelf Load
up to **175kg** UDL

Clicka Galvanised
up to **265kg** UDL

Storeroom

Workshop

Office



KWIKRACK

Our Kwikrack offers a robust and cost effective storage solution for any application. The unique 6 fold channel beam offers shelf capacities of 300kgs with a shelf height of only 54mm. The design of the beam allows for an inset chipboard decking design with interlocking deck supports for a strong and robust shelf level.

The system is simple to erect, yet has all the strength you are likely to need. The bays just tap together with a rubber mallet so you can organise your storage in a fraction of the time it can take with more traditional systems. With a build time of just 10 minutes, large installations will be completed in no time at all.

- **Easy to assemble and re-configure**
Build a bay in 10 minutes with a rubber mallet
- **Will suit any application**
A versatile range, ideal for home, garage or industry
- **Best value shelving system**
With shelf capacities of up to 300kgs at great prices



- 300 KG Shelf Load
- Storeroom
- Workshop
- Warehouse

Heights	Widths	Depths	Application	Construction	Loadings
Standard Bay Height (mm) 2000	Widths (mm) 1000, 1200, 1500	Depths (mm) 300, 450, 600	Environment Warehouse, Storeroom, Workshop	Uprights: Steel Blue RAL5010	Shelf UDL 200, 250, 300kg
Other Available Heights (mm) 2500			Usage Multipurpose Storage, Heavy & Bulky Items, Archiving	Beams: Steel Galvanised	Max Bay Load up to 1500kgs
				Shelves/Decks Chipboard 12mm	

Industrial racking for any application



Three bay run of Kwibrack 2000 x 1000 x 450

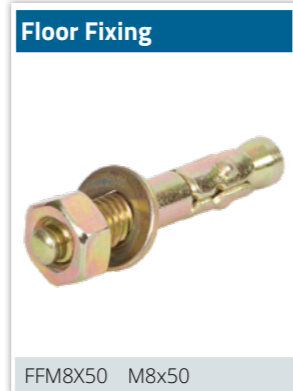
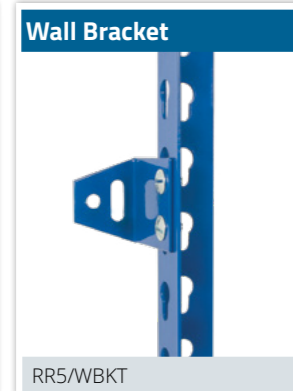

Plan your layout

Nominal Bay Width (mm)	Clear Entry (mm)	Bay Width (mm)	Bay width with plastic feet (mm)	Bay width with metal feet (mm)
1000	920	1000	1011	1013
1200	1120	1200	1211	1211
1500	1420	1500	1511	1511

Nominal Bay Depth (mm)	Clear Entry (mm)	Bay Depth (mm)	Bay Depth with plastic feet (mm)	Bay Depth with metal feet (mm)
300	220	300	311	311
450	370	450	461	461
600	520	600	611	611

Overall Height = H + 5mm Shelf Pitch = every 33.33mm
 Clear opening between levels = Total Shelf Pitch - 54mm
 First shelf level = 90mm FFL
 Bay Capacity = 1500kgs

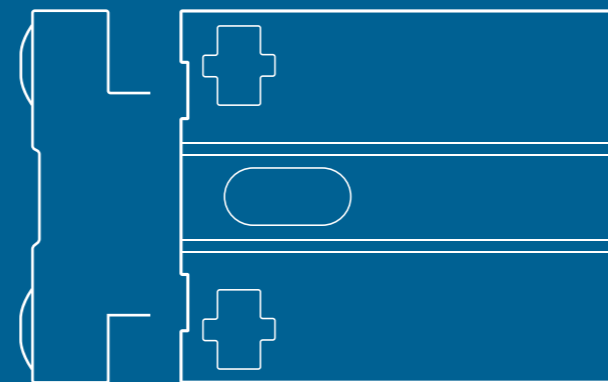

Kwibrack beam profile

Wide open bays with heavy duty shelves



Kwibrack with Archive Boxes



Kwibrack bay 2000 x 1000 x 600mm

Wide Open Bays		+Add Extra Shelves		
H x W x D (mm)	Bay Code	Shelf Load (kg)	Shelf Code	
W1000mm	2000x1000x300	KWB/20/10/03/5/BGV	300	KWS/10/03/GV
	2000x1000x450	KWB/20/10/04/5/BGV	300	KWS/10/04/GV
	2000x1000x600	KWB/20/10/06/5/BGV	300	KWS/10/06/GV
W1200mm	2000x1200x300	KWB/20/12/03/5/BGV	250	KWS/12/03/GV
	2000x1200x450	KWB/20/12/04/5/BGV	250	KWS/12/04/GV
	2000x1200x600	KWB/20/12/06/5/BGV	250	KWS/12/06/GV
W1500mm	2000x1500x300	KWB/20/15/03/5/BGV	200	KWS/15/03/GV
	2000x1500x450	KWB/20/15/04/5/BGV	200	KWS/15/04/GV
	2000x1500x600	KWB/20/15/06/5/BGV	200	KWS/15/06/GV

+For Taller Bays Add Price	
Extra Height	Code
Bays 2500mm	KWB/25/-/-/5/BGV

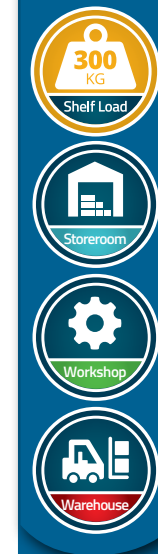



RIVET RACKING

Offers incredible value for money, whilst offering amazing strength and rigidity.

The system is simple to build with all parts being tapped together using a rubber mallet. All components are joined via the heavy duty rivet and key hole slot which offers a simple and effective way to assemble the racking.

There are no nuts and bolts and the bays require no bracing therefore offering uninterrupted access on all four sides. Bays are available in various heights up to 3660mm high.

With the average time to assemble a bay being just 5 minutes, you will be amazed at how easy it is to create large installations in no time at all. All bays are ready for immediate dispatch and will be delivered in 5 working days.

- **Best Selling system**
Offers the widest choice of sizes, all at great value
- **Easy to build and re-configure**
Simply tap together with a rubber mallet
- **Strong and sturdy**
With shelf capacities up to 600kgs, it easily copes with heavy goods
- **No nuts, bolts or screws**
Simple and quick to erect, with no fuss
- **Strong epoxy paint finish**
Designed to give years of service and withstand heavy use
- **Will suit any application**
Versatile and expandable, suits a wide range of industries
- **Guaranteed delivery in 5 days**
There when you need it, without fail



Heavy & Medium Rivet

Incredible value for money, amazing strength and rigidity. Bays come complete with 3 or more levels and have a central deck support on bays 1220mm to 2135mm wide, whilst 2440mm wide bays have two per level.

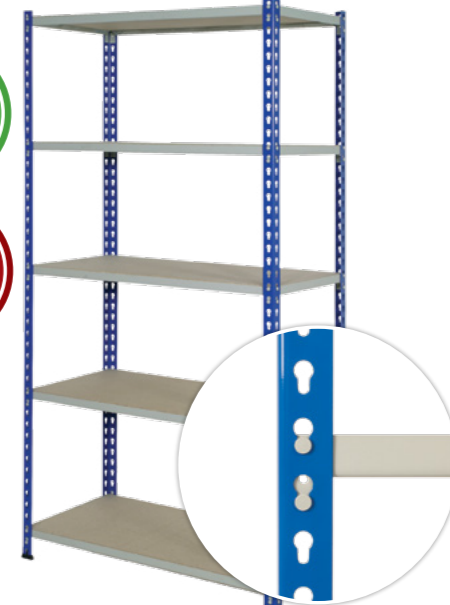

J Rivet

Our J rivet system has unbeatable strength at an incredible price. It is also manufactured to the highest quality. The shallow J beam profile (only 30mm thick) gives increased storage capacity whilst maintaining excellent strength.



Heights	Widths	Depths	Application	Construction	Loadings
Standard Bay Height (mm) 1830	Heavy Rivet Widths (mm) 915, 1220, 1525, 1830, 2135, 2440	Heavy Rivet Depths (mm) 305, 457, 610, 762, 915, 1220	Environment Warehouse, Storeroom, Workshop	Uprights: Steel Blue RAL5010	Heavy Rivet Shelf UDL 400-600kg
Other Available Heights (mm) 1980, 2135, 2440, 2745, 3050, 3660	Medium Rivet Widths (mm) 1830	Medium Rivet Depths (mm) 305, 457, 610, 762, 915, 1220	Usage Multipurpose Storage, Heavy & Bulky Items, Archiving, Garment Storage, Reel Storage	Beams: Steel Grey RAL7038 **Orange RAL2002	Medium Rivet Shelf UDL 230-300kg
Uprights can be cut to a specific size	J Rivet Widths (mm) 915, 1220	J Rivet Depths (mm) 305, 457, 610		Shelves/Decks Chipboard 15-16mm **Heavy Rivet Only	J Rivet Shelf UDL 120-150kg Max Bay Load up to 2800kg



Design and plan your Rivet Racking layout

Calculating Exact Dimensions of the Bay & Run of Bays

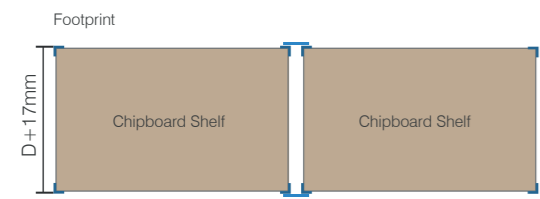
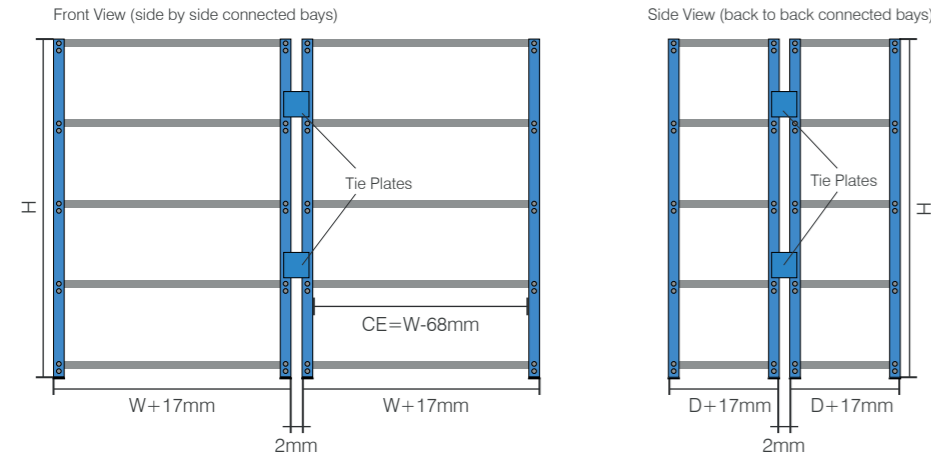

H Nominal Height*
 W Nominal Width*
 D Nominal Depth*
 CE Clear Entry between uprights
 * Dimensions used in price tables

Rivet Racking Bay Loading (kgs)

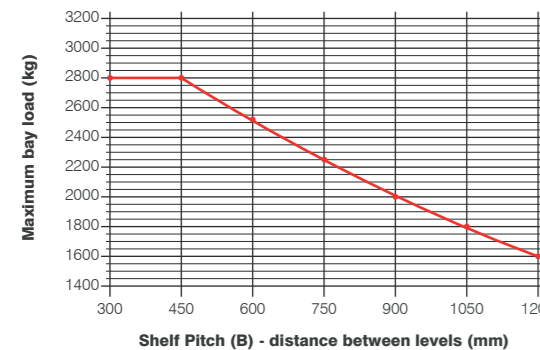

Rivet Upright

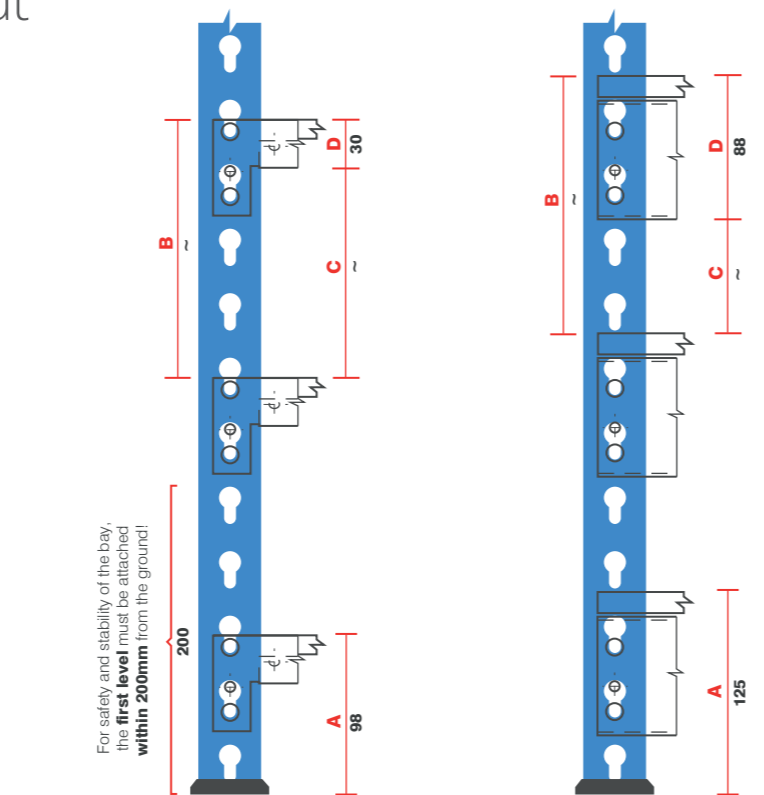
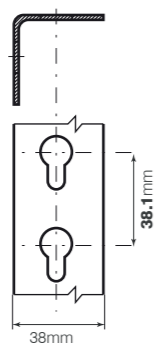

	J Rivet	Heavy Rivet
A	98mm	125mm
B	see below ① how to calculate exact Shelf Pitch	
C	B minus D	B minus D
D	30mm	88mm

A Minimum First Shelf Level Height
 B Shelf Pitch - Distance between levels
 C Clear Entry - Useable space between shelf levels
 D Shelf Thickness - Beam and chipboard

① How can you calculate exact Shelf Pitch (B)

Height of item stored + Shelf Thickness divided by **38.1**
 = Round decimal up to the next whole number and multiply by **38.1**

e.g. 320mm (Height of stored items) + 88mm (Heavy Rivet) / 38.1
 = 10.7 rounded to 11 x 38.1 = 419.1mm Shelf Pitch

Rivet Racking accessories and components

1. J Rivet Beam

Decking is flush with the top of the beam

2. Notched Side Beam

Used with tubes to create rails

3. Rivet Upright

Uprights can be up to 3660mm high

4. Tie Plate

Connects two bays together

5. Plastic Feet

Comes as a standard with every bay

6. Metal Foot

Allows the bay to be floor fixed

7. Heavy Rivet Beam

Decking sits on top of the beam

8. Tray Shelf

Reversed medium rivet 'L' beams

9. Chipboard Deck

Rivet Racking uses 15mm and 16mm decks

10. Wall Bracket

Allows the bay to be wall fixed

11. Deck Support

Adds strength to shelf levels

Industrial racking for any application



Bay Colour Options



For **Blue Uprights with Orange Shelves** add /BO to the end of your chosen price code.



For **Blue Uprights with Grey Shelves** add /BG to the end of your chosen price code.



● Rivet Racking 1830 x 1830 x 610mm Blue/Grey +Deck Support Detail

Rubber Mallet



MALLET

Tie Plate

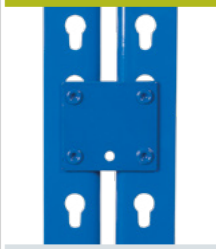

RR8/SET4 Set of 4

Wall Bracket

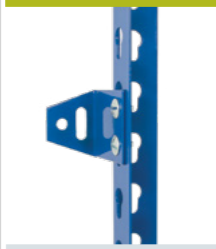

RR5/WBKT

Metal Feet



RR5/SET4 Set of 4

Floor Fixing



FFM8X50 M8x50

HEAVY RIVET

Heavy duty industrial racking that meets the demands of any warehouse, storeroom and workshop.

Rivet Racking offers incredible value for money with amazing strength and rigidity. The quality of the materials used and robust construction ensures it will meet the rigors of the toughest workplace.

The vast range of bay sizes allows for a solution to meet your storage needs and the available space. Flexibility of wide open bays and large shelf capacities enable products of varying weights and dimensions to be easily stored within a single system.

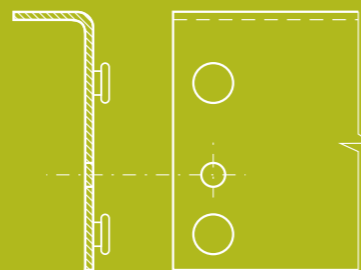

● Heavy Rivet beam profile 915, 1220 & 1525 wide

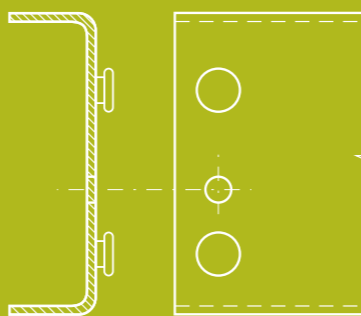

● Heavy Rivet beam profile 1830, 2135 & 2440 wide

Wide open bays with heavy duty shelves

Wide Open Bays			+Add Extra Shelves	
	H x W x D (mm)	Bay Code	Shelf Load (kg)	Shelf Code
W915mm	1830 x 915 x 305	RRB/18/09/03/3	600	RRS/09/03
	1830 x 915 x 457	RRB/18/09/04/3	600	RRS/09/04
	1830 x 915 x 610	RRB/18/09/06/3	600	RRS/09/06
	1830 x 915 x 762	RRB/18/09/07/3	600	RRS/09/07
	1830 x 915 x 915	RRB/18/09/09/3	600	RRS/09/09
W1220mm	1830 x 915 x 1220	RRB/18/09/12/3	550	RRS/09/12
	1830 x 1220 x 305	RRB/18/12/03/3	550	RRS/12/03
	1830 x 1220 x 457	RRB/18/12/04/3	550	RRS/12/04
	1830 x 1220 x 610	RRB/18/12/06/3	550	RRS/12/06
	1830 x 1220 x 762	RRB/18/12/07/3	550	RRS/12/07
W1525mm	1830 x 1220 x 915	RRB/18/12/09/3	550	RRS/12/09
	1830 x 1220 x 1220	RRB/18/12/12/3	550	RRS/12/12
	1830 x 1525 x 305	RRB/18/15/03/3	500	RRS/15/03
	1830 x 1525 x 457	RRB/18/15/04/3	500	RRS/15/04
	1830 x 1525 x 610	RRB/18/15/06/3	500	RRS/15/06
W1830mm	1830 x 1525 x 762	RRB/18/15/07/3	500	RRS/15/07
	1830 x 1525 x 915	RRB/18/15/09/3	500	RRS/15/09
	1830 x 1525 x 1220	RRB/18/15/12/3	500	RRS/15/12
	1830 x 1830 x 305	RRB/18/18/03/3	500	RRS/18/03
	1830 x 1830 x 457	RRB/18/18/04/3	500	RRS/18/04
W2135mm	1830 x 1830 x 610	RRB/18/18/06/3	500	RRS/18/06
	1830 x 1830 x 762	RRB/18/18/07/3	500	RRS/18/07
	1830 x 1830 x 915	RRB/18/18/09/3	500	RRS/18/09
	1830 x 1830 x 1220	RRB/18/18/12/3	450	RRS/18/12
	1830 x 2135 x 305	RRB/18/21/03/3	450	RRS/21/03
W2440mm	1830 x 2135 x 457	RRB/18/21/04/3	450	RRS/21/04
	1830 x 2135 x 610	RRB/18/21/06/3	450	RRS/21/06
	1830 x 2135 x 762	RRB/18/21/07/3	450	RRS/21/07
	1830 x 2135 x 915	RRB/18/21/09/3	450	RRS/21/09
	1830 x 2135 x 1220	RRB/18/21/12/3	425	RRS/21/12
W3050mm	1830 x 2440 x 305	RRB/18/24/03/3	400	RRS/24/03
	1830 x 2440 x 457	RRB/18/24/04/3	400	RRS/24/04
	1830 x 2440 x 610	RRB/18/24/06/3	400	RRS/24/06
	1830 x 2440 x 762	RRB/18/24/07/3	400	RRS/24/07
	1830 x 2440 x 915	RRB/18/24/09/3	400	RRS/24/09
W3660mm	1830 x 2440 x 1220	RRB/18/24/12/3	400	RRS/24/12
	1830 x 3050 x 305	RRB/30/03/3	400	RRS/30/03
W3660mm	1830 x 3050 x 457	RRB/30/04/3	400	RRS/30/04
	1830 x 3050 x 610	RRB/30/06/3	400	RRS/30/06
W3660mm	1830 x 3050 x 762	RRB/30/07/3	400	RRS/30/07
	1830 x 3050 x 915	RRB/30/09/3	400	RRS/30/09
W3660mm	1830 x 3050 x 1220	RRB/30/12/3	400	RRS/30/12
	1830 x 3660 x 305	RRB/36/03/3	400	RRS/36/03
W3660mm	1830 x 3660 x 457	RRB/36/04/3	400	RRS/36/04
	1830 x 3660 x 610	RRB/36/06/3	400	RRS/36/06
W3660mm	1830 x 3660 x 762	RRB/36/07/3	400	RRS/36/07
	1830 x 3660 x 915	RRB/36/09/3	400	RRS/36/09
W3660mm	1830 x 3660 x 1220	RRB/36/12/3	400	RRS/36/12
	1830 x 3660 x 1525	RRB/36/15/3	400	RRS/36/15

● Includes three levels, uprights, plastic feet, face and side beams, deck supports* and chipboard decks for all levels (*except 915mm wide).



● Rivet Racking 1830 x 1525 x 762mm Blue/Orange

+For Taller Bays Add Price

Extra Height	Code
bays 1980mm	RRB/19/--/4
bays 2135mm	RRB/21/--/4
bays 2440mm	RRB/24/--/4
bays 2745mm	RRB/27/--/4
bays 3050mm	RRB/30/--/4
bays 3660mm	RRB/36/--/4

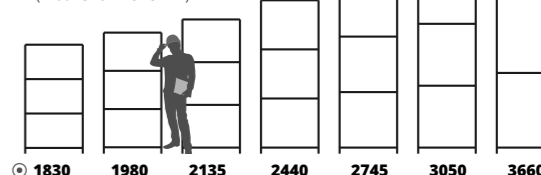
Available Heights (mm)
(width shown 915mm)

Fully adjustable, multi-purpose, heavy duty storage

Available in two different colour schemes

Best for Warehouse, Storeroom or Workshop | up to 600kg UDL/shelf

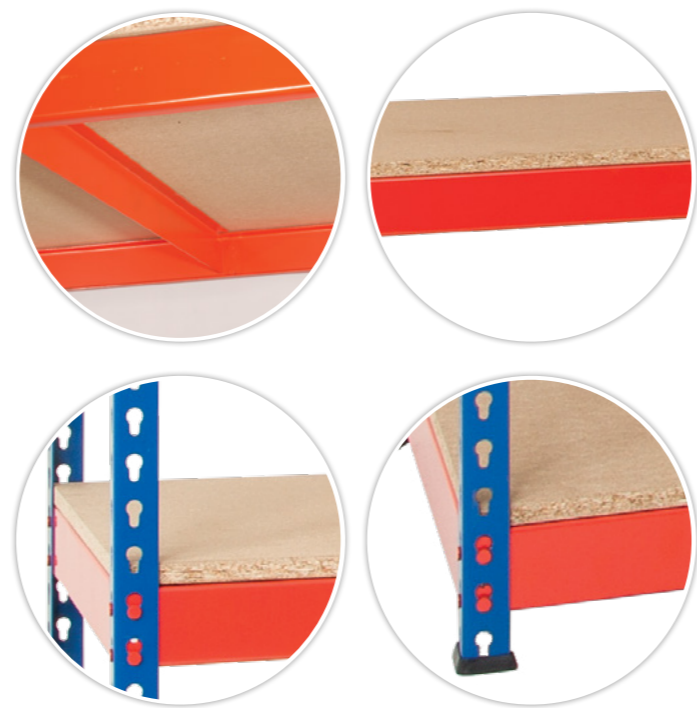

Rivet Racking 1830 x 2440 x 610mm Blue/Orange + Detail

Bay Colour Options

For Blue Uprights with Orange Shelves add /BO to the end of your chosen price code.

For Blue Uprights with Grey Shelves add /BG to the end of your chosen price code.

<p>Rubber Mallet</p> <p>MALLET</p>	<p>Tie Plate</p> <p>RR8/SET4 Set of 4</p>	<p>Wall Bracket</p> <p>RR5/WBKT</p>	<p>Metal Feet</p> <p>RR5/SET4 Set of 4</p>	<p>Floor Fixing</p> <p>FFM8X50 M8x50</p>
---	--	--	---	---

Wide Open Bays		+Add Extra Shelves		
H x W x D (mm)	Bay Code	Shelf Load (kg)	Shelf Code	
W915mm	1830 x 915 x 305	RRB/18/09/03/4	600	RRS/09/03
	1830 x 915 x 457	RRB/18/09/04/4	600	RRS/09/04
	1830 x 915 x 610	RRB/18/09/06/4	600	RRS/09/06
	1830 x 915 x 762	RRB/18/09/07/4	600	RRS/09/07
	1830 x 915 x 915	RRB/18/09/09/4	600	RRS/09/09
W1220mm	1830 x 915 x 1220	RRB/18/09/12/4	550	RRS/09/12
	1830 x 1220 x 305	RRB/18/12/03/4	550	RRS/12/03
	1830 x 1220 x 457	RRB/18/12/04/4	550	RRS/12/04
	1830 x 1220 x 610	RRB/18/12/06/4	550	RRS/12/06
	1830 x 1220 x 762	RRB/18/12/07/4	550	RRS/12/07
W1525mm	1830 x 1220 x 915	RRB/18/12/09/4	550	RRS/12/09
	1830 x 1220 x 1220	RRB/18/12/12/4	550	RRS/12/12
	1830 x 1525 x 305	RRB/18/15/03/4	500	RRS/15/03
	1830 x 1525 x 457	RRB/18/15/04/4	500	RRS/15/04
	1830 x 1525 x 610	RRB/18/15/06/4	500	RRS/15/06
W1830mm	1830 x 1525 x 762	RRB/18/15/07/4	500	RRS/15/07
	1830 x 1525 x 915	RRB/18/15/09/4	500	RRS/15/09
	1830 x 1525 x 1220	RRB/18/15/12/4	500	RRS/15/12
	1830 x 1830 x 305	RRB/18/18/03/4	500	RRS/18/03
	1830 x 1830 x 457	RRB/18/18/04/4	500	RRS/18/04
W2135mm	1830 x 1830 x 610	RRB/18/18/06/4	500	RRS/18/06
	1830 x 1830 x 762	RRB/18/18/07/4	500	RRS/18/07
	1830 x 1830 x 915	RRB/18/18/09/4	500	RRS/18/09
	1830 x 1830 x 1220	RRB/18/18/12/4	450	RRS/18/12
	W2440mm	1830 x 2135 x 305	RRB/18/21/03/4	450
1830 x 2135 x 457		RRB/18/21/04/4	450	RRS/21/04
1830 x 2135 x 610		RRB/18/21/06/4	450	RRS/21/06
1830 x 2135 x 762		RRB/18/21/07/4	450	RRS/21/07
1830 x 2135 x 915		RRB/18/21/09/4	450	RRS/21/09
W2745mm	1830 x 2135 x 1220	RRB/18/21/12/4	425	RRS/21/12
	1830 x 2440 x 305	RRB/18/24/03/4	400	RRS/24/03
	1830 x 2440 x 457	RRB/18/24/04/4	400	RRS/24/04
	1830 x 2440 x 610	RRB/18/24/06/4	400	RRS/24/06
	1830 x 2440 x 762	RRB/18/24/07/4	400	RRS/24/07
W3050mm	1830 x 2440 x 915	RRB/18/24/09/4	400	RRS/24/09
	1830 x 2440 x 1220	RRB/18/24/12/4	400	RRS/24/12

Includes four levels, uprights, plastic feet, face and side beams, deck supports* and chipboard decks for all levels (*except 915mm wide).



+For Taller Bays Add Price

Extra Height	Code
bays 1980mm	RRB/19/--/--
bays 2135mm	RRB/21/--/--
bays 2440mm	RRB/24/--/--
bays 2745mm	RRB/27/--/--
bays 3050mm	RRB/30/--/--
bays 3660mm	RRB/36/--/--

Rivet Racking 1830 x 1830 x 610mm Blue/Grey

5 YEAR Guarantee

5 DAYS Delivery

10 MIN Assembly

Boltless

2800 KG Bay Load

Storeroom

Workshop

Warehouse

HEAVY RIVET

Made with high quality, robust materials



Strong & Sturdy shelf capacities up to 600kg



Deck Supports add strength to shelf levels



Bay Colour Options

For Blue Uprights with Orange Shelves add /BO to the end of your chosen price code.

For Blue Uprights with Grey Shelves add /BG to the end of your chosen price code.

<p>Rubber Mallet</p> <p>MALLET</p>	<p>Tie Plate</p> <p>RR8/SET4 Set of 4</p>	<p>Wall Bracket</p> <p>RR5/WBKT</p>	<p>Metal Feet</p> <p>RR5/SET4 Set of 4</p>	<p>Floor Fixing</p> <p>FFM8X50 M8x50</p>
---	--	--	---	---

Perfect for the warehouse, storeroom or workshop

Wide Open Bays			+Add Extra Shelves	
	H x W x D (mm)	Bay Code	Shelf Load (kg)	Shelf Code
W915mm	1830 x 915 x 305	RRB/18/09/03/5	600	RRS/09/03
	1830 x 915 x 457	RRB/18/09/04/5	600	RRS/09/04
	1830 x 915 x 610	RRB/18/09/06/5	600	RRS/09/06
	1830 x 915 x 762	RRB/18/09/07/5	600	RRS/09/07
	1830 x 915 x 915	RRB/18/09/09/5	600	RRS/09/09
W1220mm	1830 x 915 x 1220	RRB/18/09/12/5	550	RRS/09/12
	1830 x 1220 x 305	RRB/18/12/03/5	550	RRS/12/03
	1830 x 1220 x 457	RRB/18/12/04/5	550	RRS/12/04
	1830 x 1220 x 610	RRB/18/12/06/5	550	RRS/12/06
	1830 x 1220 x 762	RRB/18/12/07/5	550	RRS/12/07
W1525mm	1830 x 1220 x 915	RRB/18/12/09/5	550	RRS/12/09
	1830 x 1220 x 1220	RRB/18/12/12/5	550	RRS/12/12
	1830 x 1525 x 305	RRB/18/15/03/5	500	RRS/15/03
	1830 x 1525 x 457	RRB/18/15/04/5	500	RRS/15/04
	1830 x 1525 x 610	RRB/18/15/06/5	500	RRS/15/06
W1830mm	1830 x 1525 x 762	RRB/18/15/07/5	500	RRS/15/07
	1830 x 1525 x 915	RRB/18/15/09/5	500	RRS/15/09
	1830 x 1525 x 1220	RRB/18/15/12/5	500	RRS/15/12
	1830 x 1830 x 305	RRB/18/18/03/5	500	RRS/18/03
	1830 x 1830 x 457	RRB/18/18/04/5	500	RRS/18/04
W2135mm	1830 x 1830 x 610	RRB/18/18/06/5	500	RRS/18/06
	1830 x 1830 x 762	RRB/18/18/07/5	500	RRS/18/07
	1830 x 1830 x 915	RRB/18/18/09/5	500	RRS/18/09
	1830 x 1830 x 1220	RRB/18/18/12/5	450	RRS/18/12
	1830 x 2135 x 305	RRB/18/21/03/5	450	RRS/21/03
W2440mm	1830 x 2135 x 457	RRB/18/21/04/5	450	RRS/21/04
	1830 x 2135 x 610	RRB/18/21/06/5	450	RRS/21/06
	1830 x 2135 x 762	RRB/18/21/07/5	450	RRS/21/07
	1830 x 2135 x 915	RRB/18/21/09/5	450	RRS/21/09
	1830 x 2135 x 1220	RRB/18/21/12/5	425	RRS/21/12
W2745mm	1830 x 2440 x 305	RRB/18/24/03/5	400	RRS/24/03
	1830 x 2440 x 457	RRB/18/24/04/5	400	RRS/24/04
	1830 x 2440 x 610	RRB/18/24/06/5	400	RRS/24/06
	1830 x 2440 x 762	RRB/18/24/07/5	400	RRS/24/07
	1830 x 2440 x 915	RRB/18/24/09/5	400	RRS/24/09
W3050mm	1830 x 2440 x 1220	RRB/18/24/12/5	400	RRS/24/12

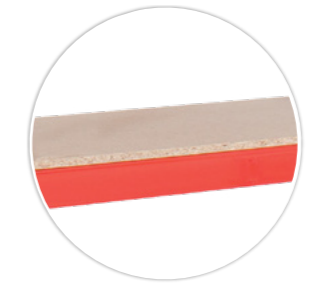
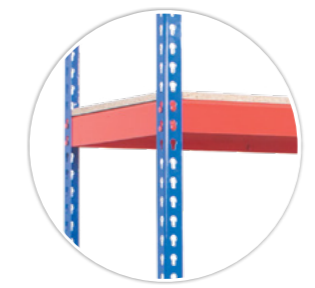

+For Taller Bays Add Price

Extra Height	Code
Bays 1980mm	RRB/19/--/--
Bays 2135mm	RRB/21/--/--
Bays 2440mm	RRB/24/--/--
Bays 2745mm	RRB/27/--/--
Bays 3050mm	RRB/30/--/--
Bays 3660mm	RRB/36/--/--



⊙ Rivet Racking 1830 x 915 x 457mm Blue/Orange

5 YEAR Guarantee

5 DAYS Delivery

10 MINS Assembly

Boltless

ⓘ Includes five levels, uprights, plastic feet, face and side beams, deck supports* and chipboard decks for all levels (*except 915mm wide).

2800 KG Bay Load

Storeroom

Workshop

Warehouse

Solid Steel Decking

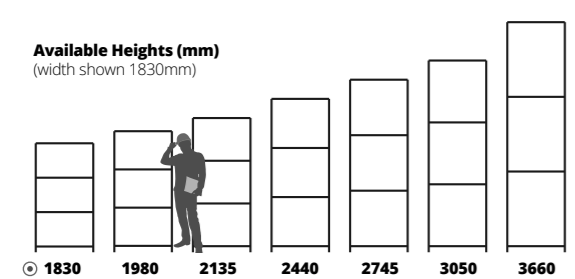

+For Taller Bays Add Price

Extra Height	Code
Bays 1980mm	RRB/19/-/-/-
Bays 2135mm	RRB/21/-/-/-
Bays 2440mm	RRB/24/-/-/-
Bays 2745mm	RRB/27/-/-/-
Bays 3050mm	RRB/30/-/-/-
Bays 3660mm	RRB/36/-/-/-

Size - HxWxD (mm)	Bay Code	Shelf Load/Kg	Shelf Code
1830 x 915 x 457	RRBSD/18/09/04/4	360	RRSSD/09/04
1830 x 915 x 610	RRBSD/18/09/06/4	360	RRSSD/09/06
1830 x 915 x 762	RRBSD/18/09/07/4	360	RRSSD/09/07
1830 x 915 x 915	RRBSD/18/09/09/4	300	RRSSD/09/09
1830 x 915 x 1220	RRBSD/18/09/12/4	270	RRSSD/09/12
1830 x 1220 x 457	RRBSD/18/12/04/4	480	RRSSD/12/04
1830 x 1220 x 610	RRBSD/18/12/06/4	480	RRSSD/12/06
1830 x 1220 x 762	RRBSD/18/12/07/4	480	RRSSD/12/07
1830 x 1220 x 915	RRBSD/18/12/09/4	400	RRSSD/12/09
1830 x 1220 x 1220	RRBSD/18/12/12/4	360	RRSSD/12/12
1830 x 1830 x 457	RRBSD/18/18/04/4	500	RRSSD/18/04
1830 x 1830 x 610	RRBSD/18/18/06/4	500	RRSSD/18/06
1830 x 1830 x 762	RRBSD/18/18/07/4	500	RRSSD/18/07
1830 x 1830 x 915	RRBSD/18/18/09/4	500	RRSSD/18/09
1830 x 1830 x 1220	RRBSD/18/18/12/4	450	RRSSD/18/12
1830 x 2135 x 457	RRBSD/18/21/04/4	450	RRSSD/21/04
1830 x 2135 x 610	RRBSD/18/21/06/4	450	RRSSD/21/06
1830 x 2135 x 762	RRBSD/18/21/07/4	450	RRSSD/21/07
1830 x 2135 x 915	RRBSD/18/21/09/4	450	RRSSD/21/09
1830 x 2135 x 1220	RRBSD/18/21/12/4	425	RRSSD/21/12
1830 x 2440 x 457	RRBSD/18/24/04/4	400	RRSSD/24/04
1830 x 2440 x 610	RRBSD/18/24/06/4	400	RRSSD/24/06
1830 x 2440 x 762	RRBSD/18/24/07/4	400	RRSSD/24/07
1830 x 2440 x 915	RRBSD/18/24/09/4	400	RRSSD/24/09
1830 x 2440 x 1220	RRBSD/18/24/12/4	400	RRSSD/24/12

All bays come with uprights, plastic feet, perimeter beams, deck supports & galvanised steel decking.

● Rivet Racking 1830 x 1830 x 610mm Blue/Grey

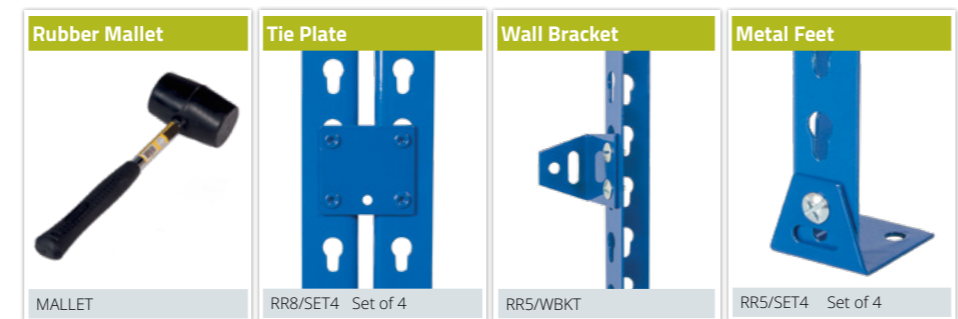

Wire Mesh Decking



Size - HxWxD (mm)	Bay Code	Shelf Load/Kg	Shelf Code
1830 x 915 x 457	RRBWD/18/09/04/4	600	RRSWD/09/04
1830 x 915 x 610	RRBWD/18/09/06/4	600	RRSWD/09/06
1830 x 915 x 762	RRBWD/18/09/07/4	600	RRSWD/09/07
1830 x 915 x 915	RRBWD/18/09/09/4	600	RRSWD/09/09
1830 x 915 x 1220	RRBWD/18/09/12/4	550	RRSWD/09/12
1830 x 1220 x 457	RRBWD/18/12/04/4	550	RRSWD/12/04
1830 x 1220 x 610	RRBWD/18/12/06/4	550	RRSWD/12/06
1830 x 1220 x 762	RRBWD/18/12/07/4	550	RRSWD/12/07
1830 x 1220 x 915	RRBWD/18/12/09/4	550	RRSWD/12/09
1830 x 1220 x 1220	RRBWD/18/12/12/4	550	RRSWD/12/12
1830 x 1830 x 457	RRBWD/18/18/04/4	500	RRSWD/18/04
1830 x 1830 x 610	RRBWD/18/18/06/4	500	RRSWD/18/06
1830 x 1830 x 762	RRBWD/18/18/07/4	500	RRSWD/18/07
1830 x 1830 x 915	RRBWD/18/18/09/4	500	RRSWD/18/09
1830 x 1830 x 1220	RRBWD/18/18/12/4	450	RRSWD/18/12
1830 x 2135 x 457	RRBWD/18/21/04/4	450	RRSWD/21/04
1830 x 2135 x 610	RRBWD/18/21/06/4	450	RRSWD/21/06
1830 x 2135 x 762	RRBWD/18/21/07/4	450	RRSWD/21/07
1830 x 2135 x 915	RRBWD/18/21/09/4	450	RRSWD/21/09
1830 x 2135 x 1220	RRBWD/18/21/12/4	425	RRSWD/21/12
1830 x 2440 x 457	RRBWD/18/24/04/4	400	RRSWD/24/04
1830 x 2440 x 610	RRBWD/18/24/06/4	400	RRSWD/24/06
1830 x 2440 x 762	RRBWD/18/24/07/4	400	RRSWD/24/07
1830 x 2440 x 915	RRBWD/18/24/09/4	400	RRSWD/24/09
1830 x 2440 x 1220	RRBWD/18/24/12/4	400	RRSWD/24/12

All bays come with uprights, plastic feet, perimeter beams, deck supports & wire mesh decking.

● Rivet Racking 1830 x 1830 x 610mm Blue/Grey

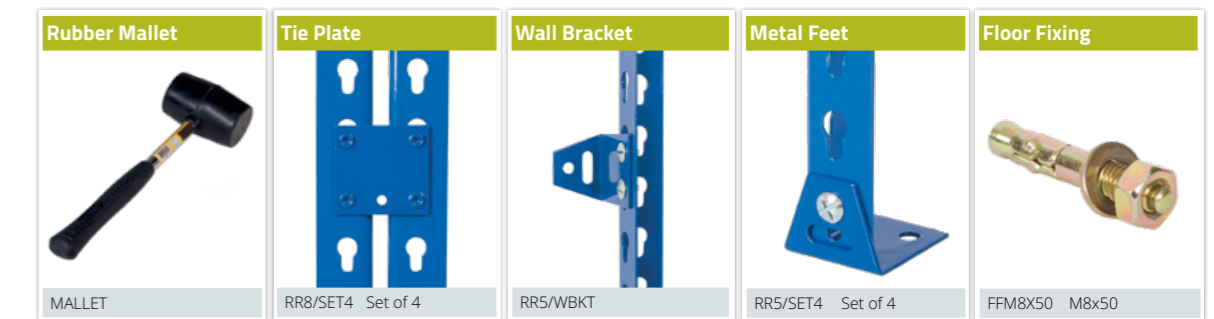

+For Taller Bays Add Price

Extra Height	Code
bays 1980mm	RRB/19/-/-/-4
bays 2135mm	RRB/21/-/-/-4
bays 2440mm	RRB/24/-/-/-4
bays 2745mm	RRB/24/-/-/-4
bays 3050mm	RRB/30/-/-/-4
bays 3660mm	RRB/36/-/-/-4



Our lowest priced Rivet Shelving system



Run of J Rivet bays connected with Tie Plates

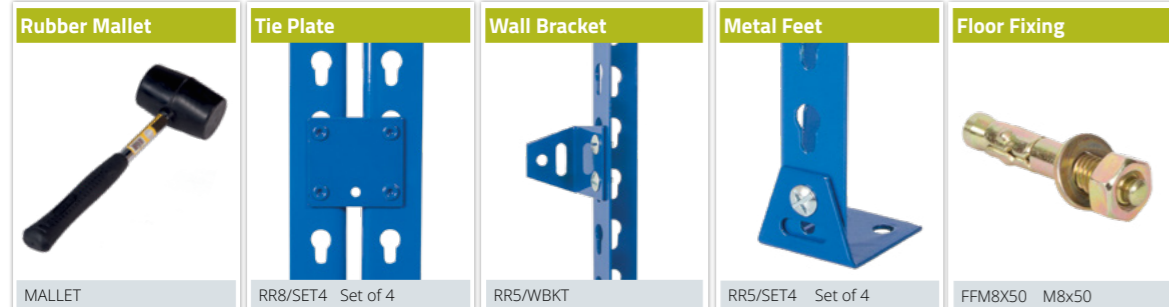

J RIVET

Fully flexible, low cost shelving system

Our J Rivet system offers unbeatable strength at an incredible price, manufactured to the high quality you have come to expect from one of the UK's leading suppliers.

The shallow J beam profile provides increased storage capacity whilst maintaining excellent strength. To maximise flexibility, our J Rivet range is compatible with our incredible Heavy Rivet range.

The system is simple to erect yet has all the strength you are likely to need with a bay load of up to 2800kg. The bays simply tap together with a rubber mallet so you can organize your storage in a fraction of the time it can take with more traditional systems.

With the average time to assemble a bay being just 5 minutes, you will be amazed at how easy it is to create large installations.

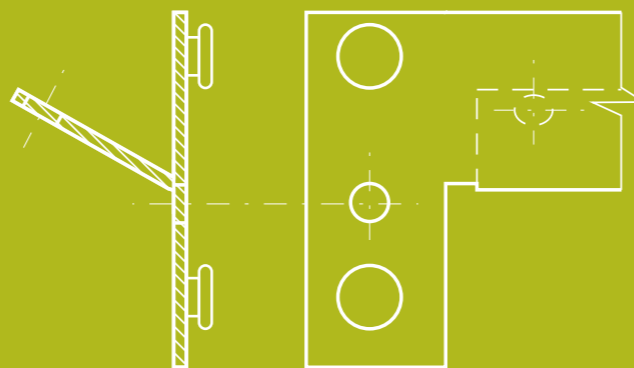

J Rivet beam profile

Strong, sturdy and simple to build

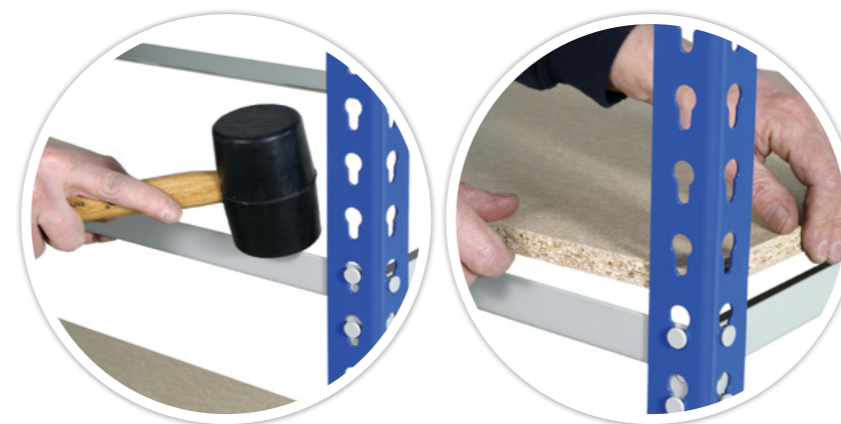

J Rivet Bay 1830 x 915 x 457mm



Available Heights (mm) (width shown 915mm)

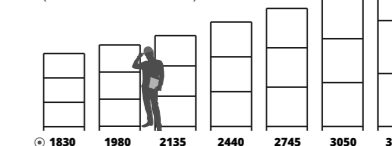

J Rivet Bays			+Add Extra Shelf	
H x W x D (mm)	Bay Code	Shelf Load (kg)	Shelf Code	
W915mm	1830 x 915 x 305	JRB/18/09/03/5/BG	150	JRS/09/03/GY
	1830 x 915 x 457	JRB/18/09/04/5/BG	150	JRS/09/04/GY
	1830 x 915 x 610	JRB/18/09/06/5/BG	150	JRS/09/06/GY
W1220mm	1830 x 1220 x 305	JRB/18/12/03/5/BG	120	JRS/12/03/GY
	1830 x 1220 x 457	JRB/18/12/04/5/BG	120	JRS/12/04/GY
	1830 x 1220 x 610	JRB/18/12/06/5/BG	120	JRS/12/06/GY

Includes five levels, uprights, plastic feet, face and side beams and chipboard decks for all levels

+For Taller Bays Add Price

Extra Height	Code
bays 1980mm	RRB/19/--/5
bays 2135mm	RRB/21/--/5
bays 2440mm	RRB/24/--/5
bays 2745mm	RRB/27/--/5
bays 3050mm	RRB/30/--/5
bays 3660mm	RRB/36/--/5

Available with plastic bins



Turn to Page 125
for J Rivet with Plastic Bins



RIVET DIVIDER SYSTEM

Our Rivet Divider System provides an effective way to store loose or awkward items. The bays provide multiple locations for separating individual products.

The system uses our Heavy Rivet Racking solution with bespoke shelves, dividers and cladding. This creates a cost effective divider system with strength and easy installation. As well as standard bays we can offer bespoke designs.

① Will suit any height or depth



② Fix divider to any position



Ⓞ Rivet Divider System 1830 x 1525 x 457 mm

Bay Colour Options

For Blue Uprights with Orange Shelves add /BO to the end of your chosen price code.

For Blue Uprights with Grey Shelves add /BG to the end of your chosen price code.

Heavy Rivet Divider System			+ Extra Compartment Dividers		+ Side Cladding (1830mm high)	
H x W x D (mm)	Bay Code	Shelf Load (kgs)	D x H (mm)	Code	H x D (mm)	Code
1830 x 1525 x 457	RRCD/18/15/04/4	500	457 x 571	RRCD/45/57	1830 x 457	ZRC/18/04/SC
1830 x 1525 x 610	RRCD/18/15/06/4	500	610 x 571	RRCD/61/57	1830 x 610	ZRC/18/06/SC
1830 x 1830 x 457	RRCD/18/18/04/4	500	457 x 571	RRCD/45/57	1830 x 457	ZRC/18/04/SC
1830 x 1830 x 610	RRCD/18/18/06/4	500	610 x 571	RRCD/61/57	1830 x 610	ZRC/18/06/SC
1830 x 2440 x 457	RRCD/18/24/04/4	400	457 x 571	RRCD/45/57	1830 x 457	ZRC/18/04/SC
1830 x 2440 x 610	RRCD/18/24/06/4	400	610 x 571	RRCD/61/57	1830 x 610	ZRC/18/06/SC

① All bays are supplied with four levels, uprights, plastic feet, perimeter beams, deck supports, chipboard decking, dividers, brackets and fixings. Dividers are supplied with brackets. Side cladding is constructed from 16mm Chipboard and is supplied with all required fixings and washers. (Some drilling and fixing required). Available in blue/grey and blue/orange.

HEAVY RIVET MFC

The Heavy Rivet MFC offers the same incredible rigidity of the standard model combined with clean, wipe down melamine shelving.

Heavy Rivet MFC offers incredible shelf loading capacities of up to 500kg. The hard wearing edged White MFC shelving finish offers additional resilience and is extremely easy to maintain.

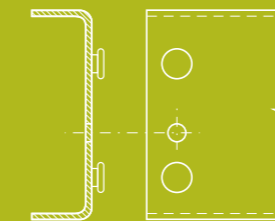

Heavy Rivet beam profile 1830, 2135 & 2440 wide

Heavy Rivet MFC Bays

+Adding Extra Shelf

H x W x D (mm)	Bay Code	Shelf Load (kg)	Shelf Code
1830 x 915 x 610	RRB/M/18/09/06/4	600	RRS/M/09/06
1830 x 915 x 762	RRB/M/18/09/07/4	600	RRS/M/09/07
1830 x 915 x 915	RRB/M/18/09/09/4	600	RRS/M/09/09
1830 x 1220 x 610	RRB/M/18/12/06/4	550	RRS/M/12/06
1830 x 1220 x 762	RRB/M/18/12/07/4	550	RRS/M/12/07
1830 x 1220 x 915	RRB/M/18/12/09/4	550	RRS/M/12/09
1830 x 1830 x 610	RRB/M/18/18/06/4	500	RRS/M/18/06
1830 x 1830 x 762	RRB/M/18/18/07/4	500	RRS/M/18/07
1830 x 1830 x 915	RRB/M/18/18/09/4	500	RRS/M/18/09
1830 x 2440 x 610	RRB/M/18/24/06/4	400	RRS/M/24/06
1830 x 2440 x 762	RRB/M/18/24/07/4	400	RRS/M/24/07
1830 x 2440 x 915	RRB/M/18/24/09/4	400	RRS/M/24/09

① Heavy Rivet MFC Bays come with four White melamine shelf levels as standard. Bay price also includes uprights, plastic feet, face and side beams.



+For Taller Bays Add Price

Extra Height Code

bays 1980mm	RRB/M/19/--/4
bays 2135mm	RRB/M/21/--/4
bays 2440mm	RRB/M/24/--/4
bays 2745mm	RRB/M/27/--/4
bays 3050mm	RRB/M/30/--/4
bays 3660mm	RRB/M/36/--/4

Bay Colour Options

For Blue Uprights with Orange Shelves add /BO to the end of your chosen price code.

For Blue Uprights with Grey Shelves add /BG to the end of your chosen price code.



Shelf Bins & Additional Dividers

If you need a strong, robust and versatile bin storage solution, at a competitive price – then look no further.

Our new range of Shelf Bins have been designed to offer a range of bins in "Big Sizes" for storing large parts or increased volumes. They can fit both small parts shelving systems as well as larger bays, such as Rivet or Longspan.

They have many new features, such as internal dividers that securely locate into 7 different locations. There is also an integral back stop allowing the bin to be suspended out from the shelving, for ease of picking.

With a semi-open front and a large labelling area below, ensures items can be identified quickly. The bins are available in Blue shockproof plastic and can be nested when not in use to save space.

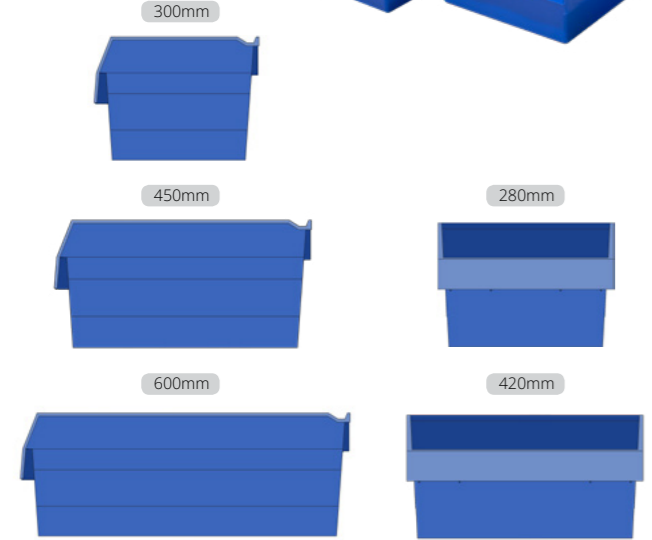

Shelf Bins		
D x W x H(mm)	Code	Colour
300x280x200mm	SFB302820	Blue
450x280x200mm	SFB452820	Blue
450x420x200mm	SFB454220	Blue
600x280x200mm	SFB602820	Blue
600x420x200mm	SFB604220	Blue

Add Dividers		
W x H(mm)	Code	Colour
280x200mm	SFD2820	Black
420x200mm	SFD4220	Black



Features

- 1 Integral back stop
- 2 Profiled sides for extra strength
- 3 Nestable design – space saving
- 4 Large labelling area
- 5 Semi-open fronted design
- 6 7 divider positions in each bin
- 7 Dividers positively slot into the bin

Rivet Racking Bays with Bins



Rivet Racking with 280mm Shelf Bins		
H x W x D (mm)	Bin Qty	Code
1980 x 915 x 305	18	RRSFB03A
1980 x 915 x 457	18	RRSFB04A
1980 x 915 x 610	18	RRSFB06A

① Includes Rivet Racking bay with 7 shelf levels and 18 No. shelf bins 280mm wide.(Dividers not included)

Rivet Racking with 420mm Shelf Bins		
H x W x D (mm)	Bin Qty	Code
1980 x 915 x 457	12	RRSFB04B
1980 x 915 x 610	12	RRSFB06B

① Includes Rivet Racking bay with 7 shelf levels and 12 No. 420mm wide shelf bins.(Dividers not included)

Rivet Racking with mixed 420mm & 280mm Shelf Bins		
H x W x D (mm)	Bin Qty	Code
1980 x 915 x 457	15	RRSFB04C
1980 x 915 x 610	15	RRSFB06C

① Includes Rivet Racking bay with 7 shelf levels and 9 No. 280mm and 6 No. 420mm wide shelf bins.(Dividers not included)



Keep cable reels organised

A new solution for organising and dispensing cable and items stored in reels.

The simple side beam supports a 25mm diameter tube which can hold a variety of drums or reels. The beam is notched so the tubes can be placed in 5 different positions. Each level is then fitted with a face beam to enable the material to be passed to the user and conveniently cut to length.

The units come as either static racks or as a low level mobile trolley. Bays are available in either 915 or 1220mm wide and 610mm deep.

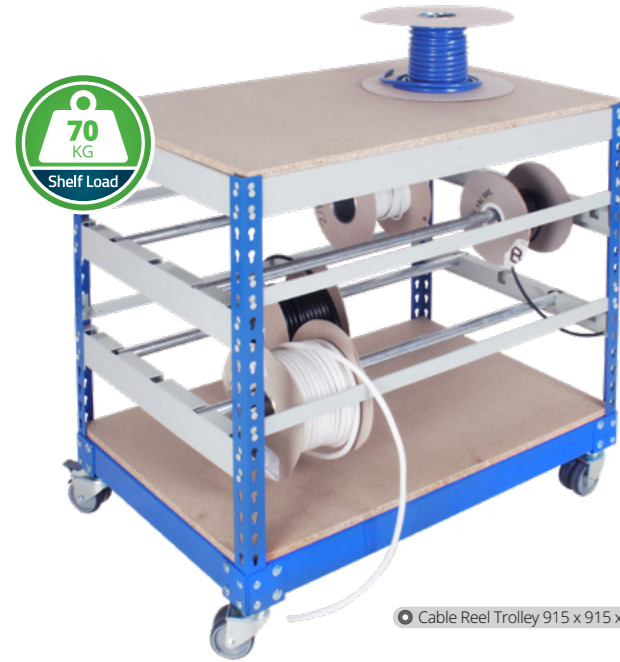

● Cable Reel Trolley 915 x 915 x 610 mm



Braked castors for additional safety



5 different positions for the tube



● Cable Reel Rack 1830 x 915 x 610 mm

Cable Reel Rack - 1830mm high

H x W x D (mm)	Code	Tube Load (kg)
● 1830 x 915 x 610	RRCB/18/09/06/4/BG	70
1830 x 1220 x 610	RRCB/18/12/06/4/BG	60

① Includes uprights, plastic feet, chipboard decks and four levels with notched beams, support beams and 8 zinc coated tubes



RIVET GARMENT RACKS

The perfect storage solution for any bulk garment hanging requirement. All constructed from Rivet racking components for simplicity and ease of assembly.

The 25mm zinc coated tube slots into place on the notched beams and can be located in five different positions. This can provide a single rail centrally positioned or two rails located on each face of the rack providing twice the capacity. Each storage level can be adjusted every 38mm.



Two single rail garment bays connected with tie plates



Bulk garment hanging storage solution



● Single Rail Garment Bay 2135 x 915 x 610 mm



● Double Rail Garment Bay 2135 x 915 x 610 mm

Single Rail Garment Bay - 2 Levels

H x W x D (mm)	Code	Tube Load (kg)
● 2135 x 915 x 610	RRGB/SG/21/09/06/2/BG	70
2135 x 1220 x 610	RRGB/SG/21/12/06/2/BG	60

① Includes uprights, plastic feet, chipboard decks for top and bottom shelves, two levels with notched beams, support beams and 2 or 4 zinc coated tubes

Double Rail Garment Bay - 2 Levels

H x W x D (mm)	Code	Tube Load (kg)
● 2135 x 915 x 610	RRGB/DG/21/09/06/2/BG	70
2135 x 1220 x 610	RRGB/DG/21/12/06/2/BG	60

① Includes uprights, plastic feet, chipboard decks for top and bottom shelves, two levels with notched beams, support beams and 2 or 4 zinc coated tubes



Utilise space with our high density Archive solution



● Double Box Deep Rivet Archive 3050 x 1830 x 915 with 100 boxes on 5 levels

Best for Warehouse, Storeroom or Office | up to 500kg UDL/shelf

RIVET RACKING ARCHIVE

ARCHIVE STORAGE SOLUTIONS

Our Rivet Archive range is the perfect solution for high density paper storage and archiving.

Our range of Archive Storage Solutions is formed of our Heavy Rivet range combined with high quality Heavy Duty Archive boxes. Each individual box offers a loading capacity of up to 20kg, with shelves supporting a UDL of up to 500kg.

Rivet Archive is available in two depths, three heights and two widths and is perfect for the storeroom, workshop or warehouse.

Need More Boxes?

Our Heavy Duty Archive box and lid are designed to hold 20kgs of paper. The robust construction means documents will be securely and safely stored. The boxes come flat packed and are easy to assemble. Boxes come with handle holes for easy transportation and the internal dimensions are 250H x 330W x 390D.



H x W x D (mm)	Code
270 x 350 x 430	AK0020AB/10

Rivet Archive - 1525mm Wide



	H x W x D (mm)	Shelf Levels	Code	Box Qty
Single Box Deep Depth 457mm	1830 x 1525 x 457mm (1966mm)	3	RRAK15/24	24
	2440 x 1525 x 457mm (2614mm)	4	RRAK15/32	32
	3050 x 1525 x 457mm (3262mm)	5	RRAK15/40	40
Double Box Deep Depth 915mm	1830 x 1525 x 915mm (1966mm)	3	RRAK15/48	48
	2440 x 1525 x 915mm (2614mm)	4	RRAK15/64	64
	3050 x 1525 x 915mm (3262mm)	5	RRAK15/80	80

*Height to top of top box

Rivet Archive - 1830mm Wide

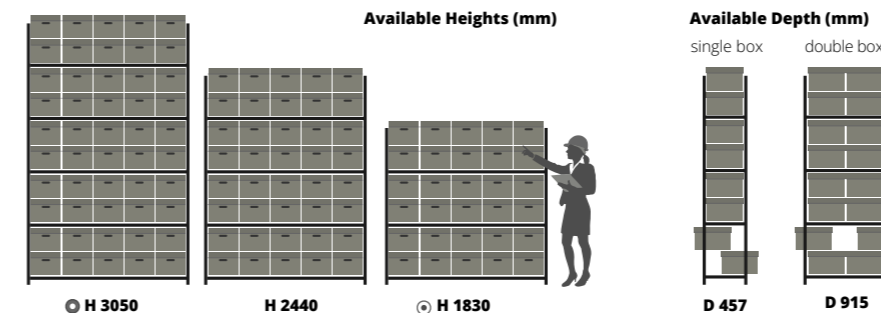

	H x W x D (mm)	Shelf Levels	Code	Box Qty
Single Box Deep Depth 457mm	⊙ 1830 x 1830 x 457mm (1966mm)	3	RRAK18/30	30
	2440 x 1830 x 457mm (2614mm)	4	RRAK18/40	40
	3050 x 1830 x 457mm (3262mm)	5	RRAK18/50	50
Double Box Deep Depth 915mm	1830 x 1830 x 915mm (1966mm)	3	RRAK18/60	60
	2440 x 1830 x 915mm (2614mm)	4	RRAK18/80	80
	⊙ 3050 x 1830 x 915mm (3262mm)	5	RRAK18/100	100

*Height to top of top box

ⓘ Includes uprights, plastic feet, perimeter beams, deck supports, chipboard decks and archive boxes with lids

Rivet Racking Archive Storage



⊙ Single Box Deep Rivet Archive 1830 x 1830 x 457 with 30 boxes on 3 levels



Available in Blue/Orange (/BO) or Blue/Grey (/BG)



RIVET RACKING ARCHIVE



RIVET BASED BENCHES & WORKSTATIONS

A cost effective answer to solve your busy packing and assembly areas.

Strong and simple to build these workbenches come in a wide range of sizes that will suit most applications.

We now offer 2 styles of worktops - Chipboard and White MFC with the MFC tops being edged with a hard wearing 1mm PVC edging.

- Easy to build and adjust
- Based on our Rivet Racking platform
- Guaranteed delivery in 5 days
- Available in blue/grey and blue/orange
- Other sizes available



Great value heavy duty Workbenches built on our Rivet Racking system



Heights	Widths	Depths	Application	Construction	Loadings
Worktop height (mm) 915	Workbench widths (mm) 915, 1220, 1525, 1830, 2135, 2440	Workbench depths (mm) 762, 915	Environment Workshop, Warehouse, Storeroom	Split Uprights: Steel Blue RAL5010	Level UDL up to 400kg
Top shelf height (mm) 1830	Workstation widths (mm) 915, 1220, 1830, 2440	Workstation depths (mm) 915	Usage Order Processing, Packing, Manufacturing	Beams: Steel Grey RAL7038 Orange RAL2002	Max Bench Load 600kg
	Packing Bench widths (mm) wide: 1525, 1830 long: 915, 1220	Packing Bench depths (mm) wide: 915 long: 1830, 2135		Worktops/Shelves Chipboard or White MFC	





© Full Undershelf Workstation with Chipboard Tops 1830 x 1830 x 915



RIVET WORKSTATIONS

Simple to build and incredibly strong.

These picking and assembly workbenches come with a strong worktop, 915mm high and two storage shelves above (305mm deep).



Chipboard Top

Blue & Orange Combination Available



Great value Workstations based on our Rivet Racking system



Available Widths (mm)

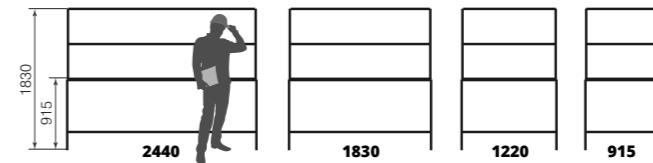

Half Undershelf Workstation - Chipboard

H x W x D (mm)	Code
1830 x 915 x 915	RRWSH/18/09/09/03
1830 x 1220 x 915	RRWSH/18/12/09/03
1830 x 1830 x 915	RRWSH/18/18/09/03
1830 x 2440 x 915	RRWSH/18/24/09/03

T Bar Workstation - Chipboard

H x W x D (mm)	Code
1830 x 915 x 915	RRWST/18/09/09/03
1830 x 1220 x 915	RRWST/18/12/09/03
1830 x 1830 x 915	RRWST/18/18/09/03
1830 x 2440 x 915	RRWST/18/24/09/03

Includes uprights, plastic feet, all necessary beams and shelves. Total workbench capacity = 600kgs** (** each shelf to carry no more than 400kgs. Floor fixing not included.)

Includes uprights, metal feet, all necessary beams and shelves. Total workbench capacity = 600kgs** (** each shelf to carry no more than 400kgs. Floor fixing required = metal feet are supplied so uprights can be fixed to the floor. Floor fixings not included.)

Includes uprights, metal feet, all necessary beams and shelves. Total workbench capacity = 600kgs** (** each shelf to carry no more than 400kgs. Floor fixing required = metal feet are supplied so uprights can be fixed to the floor. Floor fixings not included.)



A cost effective solution to your busy packing and assembly areas



Full undershelf Workbench with White MFC Tops 915 x 1830 x 915

RIVET WORKBENCHES

Strong and simple to build these workbenches come in a wide range of sizes that will suit most applications. We now offer 2 styles of 16mm chipboard or 15mm thick white MFC with the MFC tops being edged with a hard wearing 1mm PVC edging.

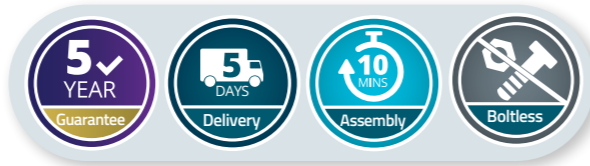

White MFC Top†



Chipboard Top



Blue/Orange Combination Available

Workbenches based on our Rivet Racking system

Available Widths (mm)

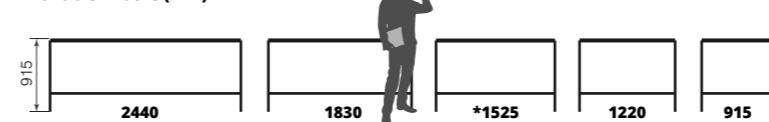

*Widths available only on workbenches with full undershelf



Workbench - Half Undershelf

H x W x D (mm)	Code (Chipboard Top)	Code (MFC Top, Chipboard Shelf)
915 x 915 x 915	RRWBH/09/09/09	RRWBH/09/09/09/M
915 x 1220 x 915	RRWBH/09/12/09	RRWBH/09/12/09/M
915 x 1830 x 915	RRWBH/09/18/09	RRWBH/09/18/09/M
915 x 2440 x 915	RRWBH/09/24/09	RRWBH/09/24/09/M

Includes uprights, metal feet, all necessary beams and shelves. Total workbench capacity = 600kgs**
 (** Each shelf to carry no more than 400kgs. Floor fixing required = metal feet are supplied so uprights can be fixed to the floor. Floor fixings not included.) †Allow 10 working days for MFC tops.



Half Undershelf Workbench with Chipboard Tops 915 x 1830 x 915

Workbench - T-Bar

H x W x D (mm)	Code (Chipboard Top)	Code (MFC Top)
915 x 915 x 762	RRWBT/09/09/07	RRWBT/09/09/07/M
915 x 915 x 915	RRWBT/09/09/09	RRWBT/09/09/09/M
915 x 1220 x 762	RRWBT/09/12/07	RRWBT/09/12/07/M
915 x 1220 x 915	RRWBT/09/12/09	RRWBT/09/12/09/M
915 x 1830 x 762	RRWBT/09/18/07	RRWBT/09/18/07/M
915 x 1830 x 915	RRWBT/09/18/09	RRWBT/09/18/09/M
915 x 2440 x 762	RRWBT/09/24/07	RRWBT/09/24/07/M
915 x 2440 x 915	RRWBT/09/24/09	RRWBT/09/24/09/M

Includes uprights, metal feet, all necessary beams and shelves. Total workbench capacity = 600kgs**
 (** Each shelf to carry no more than 400kgs. Floor fixing required = metal feet are supplied so uprights can be fixed to the floor.) †Allow 10 working days for MFC tops.



T Bar Workbench with Chipboard Top 915 x 1830 x 915

Full Undershelf Workbench

H x W x D (mm)	Code (Chipboard Top)	Code (MFC)
915 x 915 x 762	RRWB/09/09/07	RRWB/09/09/07/M
915 x 915 x 915	RRWB/09/09/09	RRWB/09/09/09/M
915 x 1220 x 762	RRWB/09/12/07	RRWB/09/12/07/M
915 x 1220 x 915	RRWB/09/12/09	RRWB/09/12/09/M
915 x 1525 x 762	RRWB/09/15/07	
915 x 1525 x 915	RRWB/09/15/09	
915 x 1830 x 762	RRWB/09/18/07	RRWB/09/18/07/M
915 x 1830 x 915	RRWB/09/18/09	RRWB/09/18/09/M
915 x 2440 x 762	RRWB/09/24/07	RRWB/09/24/07/M
915 x 2440 x 915	RRWB/09/24/09	RRWB/09/24/09/M

Includes uprights, plastic feet, all necessary beams and shelves. Total workbench capacity = 600kgs**
 (** each shelf to carry no more than 400kgs. No floor fixing required = Plastic Feet Included.) †Allow 10 working days for MFC tops.



RIVET HEAVY DUTY MOBILE WORKBENCH

Heavy Duty workbench blends the simplicity of our standard rivet style workbenches bolted to a frame, offering a sturdy and robust solution to any workplace. The bench can be fitted with a choice of 2 worktops and the base comes with heavy duty nylon swivel castors (two braked and two un-braked).

Bench Colour Options



For Blue Uprights with Orange Shelves add /BO to the end of your chosen price code.



For Blue Uprights with Grey Shelves add /BG to the end of your chosen price code.



2 levels

© Mobile Rivet Bench 880 x 1830 x 762 + Detail on the castor fixed to the upright



RIVET TROLLEY SHELVING

Our range of mobile trolley shelving enables you to move goods safely and easily between work areas, making stock moveable, easy to replenish and secure. The base can support multiple bay sizes and configurations. Levels can be configured as a tray or as a standard shelf.

- Provide flexible storage solution
- Move goods between work areas
- Maximum bay load of 300kgs
- Other sizes and specials available



Trolley Colour Options



For Blue Uprights with Orange Shelves add /BO to the end of your chosen price code.



For Blue Uprights with Grey Shelves add /BG to the end of your chosen price code.

Trolley Shelving

H x W x D (mm)	Code
1950 x 915 x 610	TRB/18/09/06/4
1950 x 915 x 762	TRB/18/09/07/4
1950 x 1220 x 610	TRB/18/12/06/4
1950 x 1220 x 762	TRB/18/12/07/4

① Includes 2x braked & 2x un-braked swivel castors and fixings, uprights, beams and 4x tops

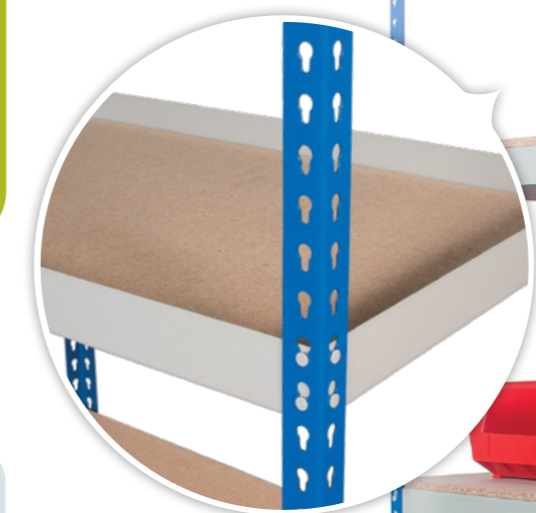

© Trolley Shelving 1950 x 915 x 610



Long Packing Workstation

RIVET PACKING WORKSTATIONS

Great packing benches in two different styles, complete with lower bubble wrap dispenser and upper paper roll dispenser.

The benches also come with an upper storage level for additional storage and, depending on the bench configuration, you get a lower storage level as well.

- Cost effective packing stations
- Two packaging roll dispensers
- Additional storage shelves

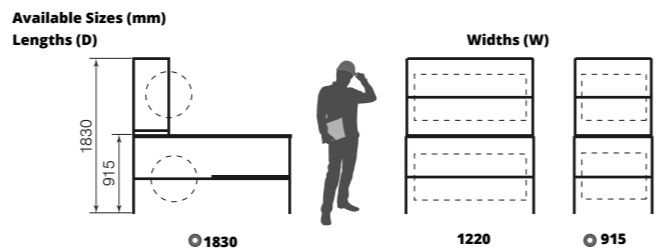

Long Packing Workstation

H x W x D (mm)	Code (Chipboard Top)
1830 x 915 x 1830	RRLPS/18/09/18/03
1830 x 1220 x 1830	RRLPS/18/12/18/03

Includes uprights, plastic feet, all necessary beams, tops and 2 x roll dispensers.

Fantastic value Wide Packing Workstation based on our Rivet Racking system

Workstation Colour Options

- For Blue Uprights with Orange Shelves add /BO to the end of your chosen price code.
- For Blue Uprights with Grey Shelves add /BG to the end of your chosen price code.



Chipboard Top

Available Sizes (mm)

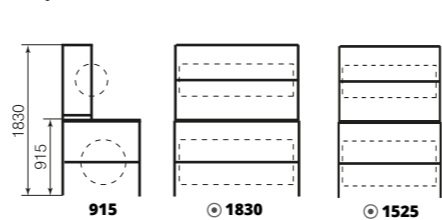

Wide Packing Workstation

H x W x D (mm)	Code (Chipboard Top)
1830 x 1525 x 915	RRWPS/18/15/09/03
1830 x 1830 x 915	RRWPS/18/18/09/03

Includes uprights, plastic feet, all necessary beams, tops and 2 x roll dispensers.



Wide Packing Station 1830 x 1830 x 915 & Detail of roll dispenser on upright





EXPO 4 BOLTLESS SHELVING

With EXPO it's as easy as 1-2-3-4

The unique friction steel clip and shelf design allows the system to be safely erected in minutes.

It now boasts one of the largest selections of modular capacities and sizes, along with an unrivalled range of accessories all finished in a high quality epoxy powder coat paint or galvanised finish.

EXPO 4 offers designers and specifiers a solution to meet any design brief, whether it's a few bays for the office, a multi-tier system or high bay project for the warehouse.

- **Clip fit shelving**
All steel shelf adjustable on steel shelf clips
- **Strong and simple to build**
Build bays quickly and easily adjust shelves
- **Flexible storage systems**
Easily adapts to your changing storage needs
- **Hard wearing painted or galvanised finish**
Offers a clean and bright epoxy powder paint finish
- **Huge range of accessories**
Solves all your storage problems, now and for the future



EXPO.....one upright with four interchangeable shelf styles

EXPO 4 FULL DETAILS TURN TO PAGE 51



The original shelf design, that comes with a wide range of sizes and capacities, all in a hard wearing light grey (RAL7038) epoxy powder coated finish.

EXPO 4G FULL DETAILS TURN TO PAGE 50



The latest addition to the range which offers a competitive, hard wearing galvanised finish, with shelf capacities up to 200kgs.



EXPO 4D FULL DETAILS TURN TO PAGE 54



A slotted shelf design, that allows a range of dividers to be integrated into the shelf, which can form compartments within the bay. All in a pure white (RAL9010) epoxy powder coated finish.

EXPO 3 FULL DETAILS TURN TO PAGE 56



The "EXTRA" Heavy duty shelf, with shelf capacities up to 300kgs and shelf sizes from 1300mm wide and 1000mm deep. All in a hard wearing galvanised finish.



EXPO 4G

EXPO 4G Offers loadings of up to 200kgs per shelf and is supplied in an all-Galvanised finish, it is the ideal solution for all kinds of storage solutions.

A traditional shelf supported on 4 clips and fully adjustable in increments of 25mm to give maximum flexibility. EXPO 4G has shelf depths of 300, 400, 500 and 600mm and frame heights of 2000, 2200, 2500 and 3000mm.



EXPO 4

The "Original" Expo 4 shelf designs offer loadings of up to 200kgs but in a hard-wearing painted finish (RAL7038). Each shelf can be adjusted every 25mm along the upright (Blue RAL5010) providing a quick and simple way to position each shelf.

The shelves come in three widths and four depths from stock, bay heights range from 2000-3000mm from stock but others size and capacities are available to order.

So, whether it's a few bays for the office, a multi-tier or high bay project for the warehouse, we have the solution to meet your needs.

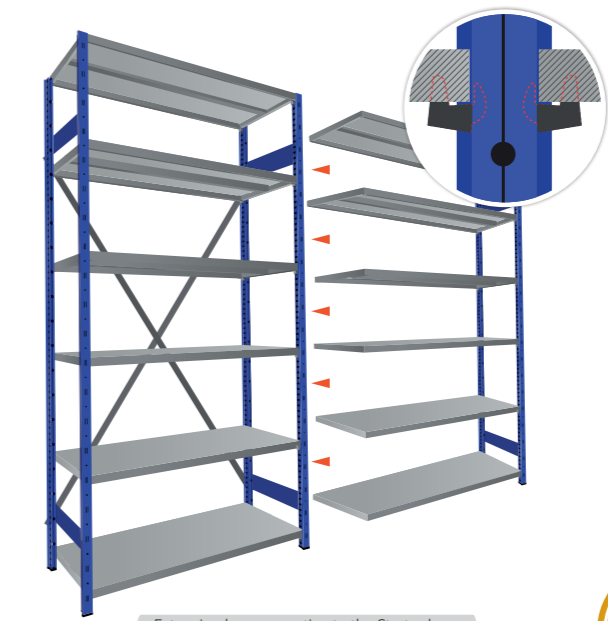

Extension bay connecting to the Starter bay -detail shelf clips with shelves on an upright

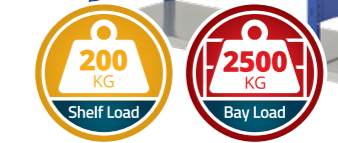

+For Taller Bays Add Price			
	Height (mm)	Starter Bay Code	Extension Bay Code
D300mm	2200	E4SG/22-03/6	E4EG/22-03/6
	2500	E4SG/25-03/6	E4EG/25-03/6
	3000	E4SG/30-03/6	E4EG/30-03/6
D400mm	2200	E4SG/22-04/6	E4EG/22-04/6
	2500	E4SG/25-04/6	E4EG/25-04/6
	3000	E4SG/30-04/6	E4EG/30-04/6
D500mm	2200	E4SG/22-05/6	E4EG/22-05/6
	2500	E4SG/25-05/6	E4EG/25-05/6
	3000	E4SG/30-05/6	E4EG/30-05/6
D600mm	2200	E4SG/22-06/6	E4EG/22-06/6
	2500	E4SG/25-06/6	E4EG/25-06/6
	3000	E4SG/30-06/6	E4EG/30-06/6

Replace '-' with Width (07=700 / 10=1000 / 11=1150) Replace '-' with Width (07=700 / 10=1000 / 11=1150)

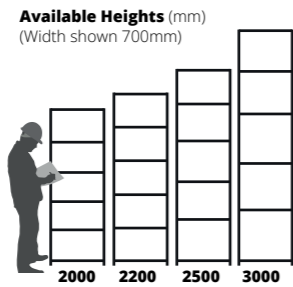

EXPO 4 Galvanised Open Bays		+Add Extension Bay	+Add Extra Shelves		
	H x W x D (mm)	Starter Bay Code	Extension Bay Code	Shelf Code	Shelf Load (kg)
D300mm	2000 x 700 x 300	E4SGG/200703/6	E4EGG/200703/6	E4G/0703SH	150
	2000 x 1000 x 300	E4SGG/201003/6	E4EGG/201003/6	E4G/1003SH	150
	2000 x 1150 x 300	E4SGG/201103/6	E4EGG/201103/6	E4G/1103SH	120
D400mm	2000 x 700 x 400	E4SGG/200704/6	E4EGG/200704/6	E4G/0704SH	120
	2000 x 1000 x 400	E4SGG/201004/6	E4EGG/201004/6	E4G/1004SH	200
	2000 x 1150 x 400	E4SGG/201104/6	E4EGG/201104/6	E4G/1104SH	170
D500mm	2000 x 700 x 500	E4SGG/200705/6	E4EGG/200705/6	E4G/0705SH	200
	2000 x 1000 x 500	E4SGG/201005/6	E4EGG/201005/6	E4G/1005SH	200
	2000 x 1150 x 500	E4SGG/201105/6	E4EGG/201105/6	E4G/1105SH	160
D600mm	2000 x 700 x 600	E4SGG/200706/6	E4EGG/200706/6	E4G/0706SH	200
	2000 x 1000 x 600	E4SGG/201006/6	E4EGG/201006/6	E4G/1006SH	180
	2000 x 1150 x 600	E4SGG/201106/6	E4EGG/201106/6	E4G/1106SH	140

① All bays come with 6 shelves per bay and all necessary fixings, bracing and plastic feet. Extension bay comes with 2 uprights only. 1 pair of Cross Bracing required per four bays.

EXPO 4 Open Bays		+Add Extension Bay	+Add Extra Shelves		
	H x W x D (mm)	Starter Bay Code	Extension Bay Code	Shelf Code	Shelf Load (kg)
D300mm	2000 x 700 x 300	E4S/200703/6	E4E/200703/6	E4/0703SH	140
	2000 x 1000 x 300	E4S/201003/6	E4E/201003/6	E4/1003SH	110
	2000 x 1150 x 300	E4S/201103/6	E4E/201103/6	E4/1103SH	90
D400mm	2000 x 700 x 400	E4S/200704/6	E4E/200704/6	E4/0704SH	130
	2000 x 1000 x 400	E4S/201004/6	E4E/201004/6	E4/1004SH	200
	2000 x 1150 x 400	E4S/201104/6	E4E/201104/6	E4/1104SH	180
D500mm	2000 x 700 x 500	E4S/200705/6	E4E/200705/6	E4/0705SH	200
	2000 x 1000 x 500	E4S/201005/6	E4E/201005/6	E4/1005SH	180
	2000 x 1150 x 500	E4S/201105/6	E4E/201105/6	E4/1105SH	150
D600mm	2000 x 700 x 600	E4S/200706/6	E4E/200706/6	E4/0706SH	180
	2000 x 1000 x 600	E4S/201006/6	E4E/201006/6	E4/1006SH	200
	2000 x 1150 x 600	E4S/201106/6	E4E/201106/6	E4/1106SH	150

① Includes 4x uprights, 6x shelves and all necessary fixings, bracing and plastic feet. Extension bay comes with 2 uprights only. 1 pair of Cross Bracing required per four bays.

+For Taller Bays Add Price			
	Height (mm)	Starter Bay Code	Extension Bay Code
D300mm	2200	E4S/22-03/6	E4E/22-03/6
	2500	E4S/25-03/6	E4E/25-03/6
	3000	E4S/30-03/6	E4E/30-03/6
D400mm	2200	E4S/22-04/6	E4E/22-04/6
	2500	E4S/25-04/6	E4E/25-04/6
	3000	E4S/30-04/6	E4E/30-04/6
D500mm	2200	E4S/22-05/6	E4E/22-05/6
	2500	E4S/25-05/6	E4E/25-05/6
	3000	E4S/30-05/6	E4E/30-05/6
D600mm	2200	E4S/22-06/6	E4E/22-06/6
	2500	E4S/25-06/6	E4E/25-06/6
	3000	E4S/30-06/6	E4E/30-06/6

Replace '-' with Width (07=700 / 10=1000 / 11=1150) Replace '-' with Width (07=700 / 10=1000 / 11=1150)

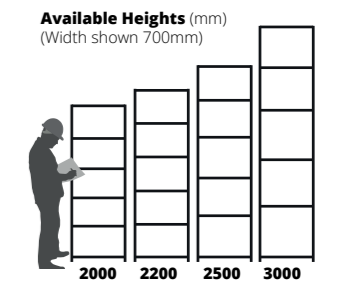

EXPO 4 side cladding options



EXPO 4 Solid Side Cladding			
	H x D (mm)	Code	
H2000mm	2000 x 300	EX10/2003/GY	H2500mm
	2000 x 400	EX10/2004/GY	
	2000 x 500	EX10/2005/GY	
	2000 x 600	EX10/2006/GY	
H2200mm	2200 x 300	EX10/2203/GY	H3000mm
	2200 x 400	EX10/2204/GY	
	2200 x 500	EX10/2205/GY	
	2200 x 600	EX10/2206/GY	

① Clad one frame. Includes multiple panels and a plastic joining rib. (light grey RAL7038)

EXPO 4 Mesh Side Cladding			
	H x D (mm)	Code	
H2000mm	2000 x 300	EX11/2003/GV	H2500mm
	2000 x 400	EX11/2004/GV	
	2000 x 500	EX11/2005/GV	
	2000 x 600	EX11/2006/GV	
H2200mm	2200 x 300	EX11/2203/GV	H3000mm
	2200 x 400	EX11/2204/GV	
	2200 x 500	EX11/2205/GV	
	2200 x 600	EX11/2206/GV	

① Clad one frame. Includes multiple panels of 2"x 2" galvanised mesh and ties.

EXPO 4 back cladding options



EXPO 4 Mesh Back Cladding		
	H x W (mm)	Code
W700mm	2000 x 700	EX12/2007/GV
	2200 x 700	EX12/2207/GV
	2500 x 700	EX12/2507/GV
	3000 x 700	EX12/3007/GV
W1000mm	2000 x 1000	EX12/2010/GV
	2200 x 1000	EX12/2210/GV
	2500 x 1000	EX12/2510/GV
	3000 x 1000	EX12/3010/GV
W1150mm	2000 x 1150	EX12/2011/GV
	2200 x 1150	EX12/2211/GV
	2500 x 1150	EX12/2511/GV
	3000 x 1150	EX12/3011/GV

① Includes multiple panels of 2"x 2" galvanized mesh and ties.

EXPO 4 Solid Sheet Back Cladding		
	H x W (mm)	Code
W700mm	2000 x 700	EX13/2007/GY
	2200 x 700	EX13/2207/GY
	2500 x 700	EX13/2507/GY
	3000 x 700	EX13/3007/GY
W1000mm	2000 x 1000	EX13/2010/GY
	2200 x 1000	EX13/2210/GY
	2500 x 1000	EX13/2510/GY
	3000 x 1000	EX13/3010/GY
W1150mm	2000 x 1150	EX13/2011/GY
	2200 x 1150	EX13/2211/GY
	2500 x 1150	EX13/2511/GY
	3000 x 1150	EX13/3011/GY

① Includes multiple solid steel sheets (light grey RAL7038) and screws.

EXPO 4 Hook In Back Cladding		
	H x W (mm)	Code
W700mm	2000 x 700	EX14/2007/GY
	2200 x 700	EX14/2207/GY
	2500 x 700	EX14/2507/GY
	3000 x 700	EX14/3007/GY
W1000mm	2000 x 1000	EX14/2010/GY
	2200 x 1000	EX14/2210/GY
	2500 x 1000	EX14/2510/GY
	3000 x 1000	EX14/3010/GY
W1150mm	2000 x 1150	EX14/2011/GY
	2200 x 1150	EX14/2211/GY
	2500 x 1150	EX14/2511/GY
	3000 x 1150	EX14/3011/GY

① Includes multiple hook in steel panels (light grey RAL7038).





EXPO 4D

Expo 4D integrates the Delta Plus shelf within the standard Expo uprights (Blue RAL5010). These shelves are finished in a pure white (RAL9010).

The shelves come slotted, this allows the use of a range of dividers to create compartments along the shelf, which are available in two widths and four depths.

Bays are supplied with six slotted shelves and are all easily adjustable on clips at a 25mm pitch. All you need to do is select the accessories you need to create any bay configurations that meets your requirements.



EXPO 4 Open Bays (White)		+Add Extension Bay	+Extra Shelf	+Add Extra Height			
H x W x D (mm)	Starter Bay Code	Extension Bay Code	Shelf Code	Shelf Load	Starter Bay Code	Extension Bay Code	
300mm	2000 x 700 x 300	E4ST/200703/6/BW	E4ET/200703/6/BW	E4/0703ST	120	E4ST/22-03/6/BW	E4ET/22-03/6/BW
	2000 x 1000 x 300	E4ST/201003/6/BW	E4ET/201003/6/BW	E4/1003ST	120	E4ST/25-03/6/BW	E4ET/25-03/6/BW
400mm	2000 x 700 x 400	E4ST/200704/6/BW	E4ET/200704/6/BW	E4/0704ST	120	E4ST/22-04/6/BW	E4ET/22-04/6/BW
	2000 x 1000 x 400	E4ST/201004/6/BW	E4ET/201004/6/BW	E4/1004ST	120	E4ST/25-04/6/BW	E4ET/25-04/6/BW
500mm	2000 x 700 x 500	E4ST/200705/6/BW	E4ET/200705/6/BW	E4/0705ST	120	E4ST/22-05/6/BW	E4ET/22-05/6/BW
	2000 x 1000 x 500	E4ST/201005/6/BW	E4ET/201005/6/BW	E4/1005ST	120	E4ST/25-05/6/BW	E4ET/25-05/6/BW
600mm	2000 x 700 x 600	E4ST/200706/6/BW	E4ET/200706/6/BW	E4/0706ST	120	E4ST/22-06/6/BW	E4ET/22-06/6/BW
	2000 x 1000 x 600	E4ST/201006/6/BW	E4ET/201006/6/BW	E4/1006ST	120	E4ST/25-06/6/BW	E4ET/25-06/6/BW
						E4ST/30_06/6/BW	E4ET/30_06/6/BW

Solid Back Cladding (Flat Sheet)	
H x W (mm)	Code
2000 x 700	EX13/2007/WH
2200 x 700	EX13/2207/WH
2500 x 700	EX13/2507/WH
3000 x 700	EX13/3007/WH
2000 x 1000	EX13/2010/WH
2200 x 1000	EX13/2210/WH
2500 x 1000	EX13/2510/WH
3000 x 1000	EX13/3010/WH

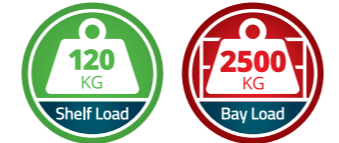

Shelves and accessories fully interchangeable with Delta Plus Steel Shelving

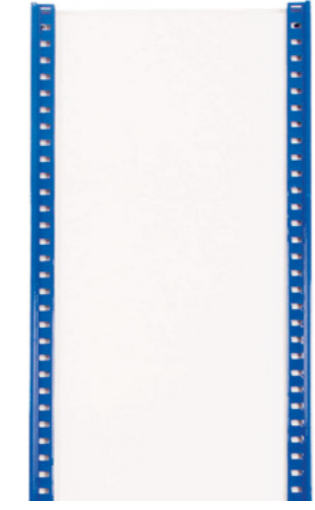

Solid Side Cladding	
H x D (mm)	Code
2000 x 300	EX10/2003/WH
2000 x 400	EX10/2004/WH
2000 x 500	EX10/2005/WH
2000 x 600	EX10/2006/WH
2200 x 300	EX10/2203/WH
2200 x 400	EX10/2204/WH
2200 x 500	EX10/2205/WH
2200 x 600	EX10/2206/WH
2500 x 300	EX10/2503/WH
2500 x 400	EX10/2504/WH
2500 x 500	EX10/2505/WH
2500 x 600	EX10/2506/WH
3000 x 300	EX10/3003/WH
3000 x 400	EX10/3004/WH
3000 x 500	EX10/3005/WH
3000 x 600	EX10/3006/WH



4. Bin Front / Back Stop	
W x H (mm)	Product Code
686 x 85	EX31/070/085/WH
986 x 85	EX31/100/085/WH

3. Freestanding Dividers	
D x H (mm)	Product Code
300 x 175	EX20/030/175/WH
400 x 175	EX20/040/175/WH
500 x 175	EX20/050/175/WH
600 x 175	EX20/060/175/WH



1. Slot In Dividers	
D x H (mm)	Product Code
300 x 95	EX32/030/095/WH
300 x 195	EX32/030/195/WH
400 x 95	EX32/040/095/WH
400 x 195	EX32/040/195/WH
500 x 95	EX32/050/095/WH
500 x 195	EX32/050/195/WH
600 x 95	EX32/060/095/WH
600 x 195	EX32/060/195/WH

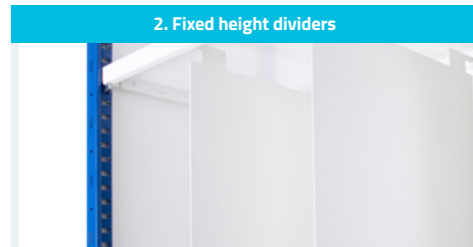

2. Fixed height dividers	
Size D x H (mm)	Product Code
300 x 300	EX33/030/300/WH
300 x 400	EX33/030/400/WH
400 x 300	EX33/040/300/WH
400 x 400	EX33/040/400/WH
500 x 300	EX33/050/300/WH
500 x 400	EX33/050/400/WH
600 x 300	EX33/060/300/WH
600 x 400	EX33/060/400/WH

Bay price includes uprights, plastic feet, shelf clips, slotted shelves and all necessary bracing and fixings.

Accessory pricing applied in addition to bay pricing. Slot-In and Fixed Height Dividers require slotted shelves (supplied as standard with white bays)



EXPO 3

Galvanised Boltless shelving.

EXPO 3 uses the same upright as our EXPO 4 shelving system, but has the unique shelf design which can have capacities up to 300kgs UDL. The design is based on a pair of shelf carriers and the combination of 100mm or 200mm panels to make up the required depth.

- **Hard wearing galvanised finish**
Tough and bright finish that will last the rigours of any environment
- **Simple to build**
Build bays quickly to get your storage problems sorted fast
- **Will suit any application**
Versatile and expandable and suits a wide range of industries
- **Interchangeable with EXPO 4 system**
Mix and match accessories and components with our EXPO 4 systems
- **Wide choice of sizes**
Flexibility to suit all your storage needs within one product



EXPO 3 galvanised boltless shelving Fully interchangeable with EXPO 4 system



EXPO 3 single shelf carrier (used for top shelf)



EXPO 3 double shelf carriers



Heights	Widths	Depths	Application	Construction	Loadings
Standard Bay Height (mm) 2000 Other Available Heights (mm) 2200, 2500, 3000	Widths (mm) 700, 1000, 1150, 1300	Depths (mm) 200, 300, 400, 500, 600, 800	Environment Warehouse, Stockroom, Workshop Usage Multipurpose Hard Wearing Storage, Multi Tier Application	Uprights: Steel Galvanised Shelf Carriers: Steel Galvanised Shelves: Steel Galvanised	Shelf UDL up to 300kg Max Bay Load 2500kg



EXPO 3 open bays

EXPO 3 Open Bays		+Add Extension Bay	+Add Extra Shelf		
H x W x D (mm)	Starter Bay Code	Extension Bay Code	Shelf Code	Shelf Load (kg)	
D200mm	2000 x 700 x 200	E3S/200702/6SD	E3E/200702/6SD	E3/0702SHSD	100
	2000 x 1000 x 200	E3S/201002/6SD	E3E/201002/6SD	E3/1002SHSD	70
	2000 x 1150 x 200	E3S/201102/6SD	E3E/201102/6SD	E3/1102SHSD	90
	2000 x 1300 x 200	E3S/201302/6SD	E3E/201302/6SD	E3/1302SHSD	70
D300mm	2000 x 700 x 300	E3S/200703/6SD	E3E/200703/6SD	E3/0703SHSD	150
	2000 x 1000 x 300	E3S/201003/6SD	E3E/201003/6SD	E3/1003SHSD	105
	2000 x 1150 x 300	E3S/201103/6SD	E3E/201103/6SD	E3/1103SHSD	135
	2000 x 1300 x 300	E3S/201303/6SD	E3E/201303/6SD	E3/1303SHSD	105
D400mm	2000 x 700 x 400	E3S/200704/6SD	E3E/200704/6SD	E3/0704SHSD	200
	2000 x 1000 x 400	E3S/201004/6SD	E3E/201004/6SD	E3/1004SHSD	140
	2000 x 1150 x 400	E3S/201104/6SD	E3E/201104/6SD	E3/1104SHSD	180
	2000 x 1300 x 400	E3S/201304/6SD	E3E/201304/6SD	E3/1304SHSD	140
D500mm	2000 x 700 x 500	E3S/200705/6SD	E3E/200705/6SD	E3/0705SHSD	250
	2000 x 1000 x 500	E3S/201005/6SD	E3E/201005/6SD	E3/1005SHSD	175
	2000 x 1150 x 500	E3S/201105/6SD	E3E/201105/6SD	E3/1105SHSD	225
	2000 x 1300 x 500	E3S/201305/6SD	E3E/201305/6SD	E3/1305SHSD	175
D600mm	2000 x 700 x 600	E3S/200706/6SD	E3E/200706/6SD	E3/0706SHSD	300
	2000 x 1000 x 600	E3S/201006/6SD	E3E/201006/6SD	E3/1006SHSD	210
	2000 x 1150 x 600	E3S/201106/6SD	E3E/201106/6SD	E3/1106SHSD	270
	2000 x 1300 x 600	E3S/201306/6SD	E3E/201306/6SD	E3/1306SHSD	210
D800mm	2000 x 700 x 800	E3S/200708/6SD	E3E/200708/6SD	E3/0708SHSD	300
	2000 x 1000 x 800	E3S/201008/6SD	E3E/201008/6SD	E3/1008SHSD	280
	2000 x 1150 x 800	E3S/201108/6SD	E3E/201108/6SD	E3/1108SHSD	300
	2000 x 1300 x 800	E3S/201308/6SD	E3E/201308/6SD	E3/1308SHSD	280



EXPO 3 starter and extension bays 2000 x 1000 x 400 - starter bay with cross brace

+Add Extra Height		
Extra Height	Bay Code	Bay Code
	Add to starter bay	Add to extension bay
2200mm	E3S/22---/SD	E3E/22---/SD
2500mm	E3S/25---/SD	E3E/25---/SD
3000mm	E3S/30---/SD	E3E/30---/SD

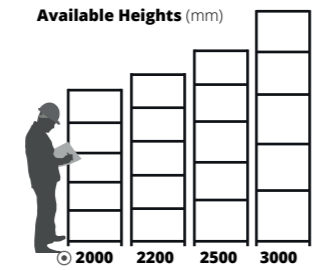

5 YEAR Guarantee, 5 DAYS Delivery, Boltless

All bays come with 6x shelves per bay and all necessary fixings, bracing, 4x uprights and plastic feet. Extension bay comes with 2x uprights only.

EXPO 3 side and back cladding options



EXPO 3 Solid Side Cladding

H x D (mm)		Code	H x D (mm)		Code
H2000mm	2000 X 200	EX10/2002/GY	H2500mm	2500 X 200	EX10/2502/GY
	2000 x 300	EX10/2003/GY		2500 x 300	EX10/2503/GY
	2000 x 400	EX10/2004/GY		2500 x 400	EX10/2504/GY
	2000 x 500	EX10/2005/GY		2500 x 500	EX10/2505/GY
	2000 X 600	EX10/2006/GY		2500 x 600	EX10/2506/GY
H2200mm	2200 X 200	EX10/2202/GY	H3000mm	3000 X 200	EX10/3002/GY
	2200 x 300	EX10/2203/GY		3000 x 300	EX10/3003/GY
	2200 x 400	EX10/2204/GY		3000 x 400	EX10/3004/GY
	2200 x 500	EX10/2205/GY		3000 x 500	EX10/3005/GY
	2200 x 600	EX10/2206/GY		3000 x 600	EX10/3006/GY
2200 X 800	EX10/2208/GY	3000 X 800	EX10/3008/GY		

Clad each frame. Includes multiple panels and a plastic joining rib (Light grey RAL7038).

EXPO 3 Hook In Back Cladding

H x W (mm)		Code
W700mm	2000 x 700	EX14/2007/GV
	2200 x 700	EX14/2207/GV
	2500 x 700	EX14/2507/GV
W1000mm	3000 x 700	EX14/3007/GV
	2000 x 1000	EX14/2010/GV
	2200 x 1000	EX14/2210/GV
W1150mm	2500 x 1000	EX14/2510/GV
	3000 x 1000	EX14/3010/GV
	2000 x 1150	EX14/2011/GV
	2200 x 1150	EX14/2211/GV
	2500 x 1150	EX14/2511/GV
3000 x 1150	EX14/3011/GV	

Includes multiple hook in steel panels (Galvanised).

EXPO 3 Mesh Back Cladding

H x W (mm)		Code
W700mm	2000 x 700	EX12/2007/GV
	2200 x 700	EX12/2207/GV
	2500 x 700	EX12/2507/GV
W1000mm	3000 x 700	EX12/3007/GV
	2000 x 1000	EX12/2010/GV
	2200 x 1000	EX12/2210/GV
W1150mm	2500 x 1000	EX12/2510/GV
	3000 x 1000	EX12/3010/GV
	2000 x 1150	EX12/2011/GV
	2200 x 1150	EX12/2211/GV
	2500 x 1150	EX12/2511/GV
3000 x 1150	EX12/3011/GV	

Includes multiple panels of 2"x 2" galvanised mesh and ties.

300 KG Shelf Load, Warehouse, Workshop, Storeroom



DELTA PLUS STEEL SHELVING

Delta Plus is our versatile steel shelving system and is the evolution of our popular Delta Edge range. Ideal for the office, library, workshop or warehouse, Delta Plus is the ultimate all-rounder.

Developed in-house in the UK, Delta Plus features an aesthetically attractive yet conveniently simple design. The system is brilliantly adaptable with a choice of plain or slotted shelves adjustable every 25mm. The system boasts a vast range of dividers and accessories making Delta Plus perfect for any brief.

Hidden shelf clips and wide open bays maximise the space available to store items. Accessories and dividers allow additional scope to organise items neatly, reducing time and stress.

- True delta edge profile
- Slotted shelves or solid shelves available
- 120kg (UDL) Shelf loading
- Huge range of dividers and accessories
- Shelf pitch every 25mm with indicators every 100mm
- Hidden shelf clips for maximised storage space
- Attractive Pure White (RAL9010) finish
- Designed in-house in the United Kingdom



Delta Profile



Slotted shelf for dividers



Distribution Centre configuration

Office configuration

E-Commerce/Garment Picking

Small Part Picking



Heights	Widths	Depths	Application	Construction	Loadings
 Bay heights (mm) 930, 1930, 2230, 2530 Other heights available on request	 Widths (mm) 700 (686), 902, 986 (1000), 1236	 Depths (mm) 300, 362, 400, 450, 500, 600	 Environment Library, Office, Storeroom, Warehouse Usage Light Storage, Filing, General Purpose Shelving, Compartment Shelving	 Side Panels: Steel Pure White RAL9010 Shelf Clips: Steel Shelves: Steel Pure White RAL9010	 Shelf UDL up to 120kg Max Bay Load 600kg



Shelf location indicator No protruding clips Delta Profile

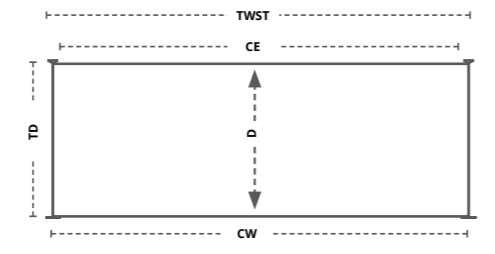

H	Nominal Height	=	930, 1930, 2230, 2530mm
W	Nominal Width	=	686, 902, 986, 1236mm
D	Nominal Depth	=	300, 362, 400, 450, 500, 600mm
CE	Clear Entry	=	(CE = W - 20mm)
TWST	Total Width Starter Bay	=	(TWST = W + 36mm)
TWEX	Total Width Extension Bay	=	(TWEX = W + 1mm)
CW	Centre Width	=	(CW = W + 1mm)
TD	Total Depth	=	(TD = D + 12mm)

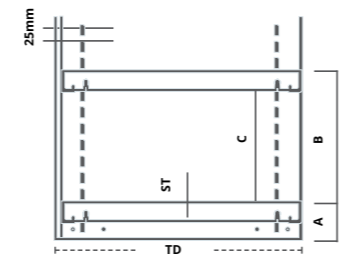

A Minimum first shelf level height = 56mm*
 B Shelf Pitch - Distance between levels = Every 25mm
 C Clear entry - space between levels
 ST Shelf Thickness = 30mm

*If using metal feet and/or a plinth, the minimum first shelf level height remains 56mm

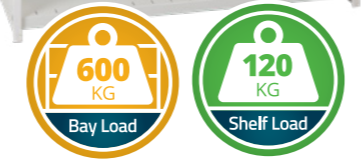

Delta Plus Open Bays		+Add Extension Bay	+Extra Shelf	+Add Extra Height				
	H x W x D (mm)	Starter Bay Code	Extension Bay Code	Shelf Code	Shelf Load	Height (mm)	Starter Bay Code	Extension Bay Code
300mm	1930 x 686 x 300	DTS/19/07/30/6	DTE/19/07/30/6	DTS/0730SH	120	2230	DTS/22/-/30/6	DTE/22/-/30/6
	1930 x 902 x 300	DTS/19/09/30/6	DTE/19/09/30/6	DTS/0930SH	120	2530	DTS/25/-/30/6	DTE/25/-/30/6
	1930 x 986 x 300	DTS/19/10/30/6	DTE/19/10/30/6	DTS/1030SH	120			
362mm	1930 x 686 x 362	DTS/19/07/36/6	DTE/19/07/36/6	DTS/0736SH	120	2230	DTS/22/-/36/6	DTE/22/-/36/6
	1930 x 902 x 362	DTS/19/09/36/6	DTE/19/09/36/6	DTS/0936SH	120	2530	DTS/25/-/36/6	DTE/25/-/36/6
	1930 x 986 x 362	DTS/19/10/36/6	DTE/19/10/36/6	DTS/1036SH	120			
400mm	1930 x 686 x 400	DTS/19/07/40/6	DTE/19/07/40/6	DTS/0740SH	120	2230	DTS/22/-/40/6	DTE/22/-/40/6
	1930 x 902 x 400	DTS/19/09/40/6	DTE/19/09/40/6	DTS/0940SH	120	2530	DTS/25/-/40/6	DTE/25/-/40/6
	1930 x 986 x 400	DTS/19/10/40/6	DTE/19/10/40/6	DTS/1040SH	120			
450mm	1930 x 686 x 450	DTS/19/07/45/6	DTE/19/07/45/6	DTS/0745SH	120	2230	DTS/22/-/45/6	DTE/22/-/45/6
	1930 x 902 x 450	DTS/19/09/45/6	DTE/19/09/45/6	DTS/0945SH	120	2530	DTS/25/-/45/6	DTE/25/-/45/6
	1930 x 986 x 450	DTS/19/10/45/6	DTE/19/10/45/6	DTS/1045SH	120			
500mm	1930 x 686 x 500	DTS/19/07/50/6	DTE/19/07/50/6	DTS/0750SH	120	2230	DTS/22/-/50/6	DTE/22/-/50/6
	1930 x 902 x 500	DTS/19/09/50/6	DTE/19/09/50/6	DTS/0950SH	120	2530	DTS/25/-/50/6	DTE/25/-/50/6
	1930 x 986 x 500	DTS/19/10/50/6	DTE/19/10/50/6	DTS/1050SH	120			
600mm	1930 x 686 x 600	DTS/19/07/60/6	DTE/19/07/60/6	DTS/0760SH	120	2230	DTS/22/-/60/6	DTE/22/-/60/6
	1930 x 902 x 600	DTS/19/09/60/6	DTE/19/09/60/6	DTS/0960SH	120	2530	DTS/25/-/60/6	DTE/25/-/60/6
	1930 x 986 x 600	DTS/19/10/60/6	DTE/19/10/60/6	DTS/1060SH	120			

All bays include 6 shelves and all necessary fixings and bracing. Starter bay = 2 x side panel. Extension bay = 1 x side panel, Bays finished in RAL9010 pure white, Maximum Bay Load 600kg

Discover the incredible range of Accessories available with the Delta Plus

1. Slot In Dividers



D x H (mm)	Product Code
300 X 95	DT08/30/09
450 X 400	DT08/30/19
362 X 95	DT08/36/09
362 X 195	DT08/36/19
400 X 95	DT08/40/09
400 X 195	DT08/40/19
450 X 95	DT08/45/09
450 X 195	DT08/45/19
500 X 95	DT08/50/09
500 X 195	DT08/50/19
600 X 95	DT08/60/09
600 X 195	DT08/60/19



2. Fixed Height Dividers



D x H (mm)	Product Code
300 X 300	DT07/30/30
300 X 400	DT07/30/40
362 X 300	DT07/36/30
362 X 400	DT07/36/40
400 X 300	DT07/40/30
400 X 400	DT07/40/40
450 X 300	DT07/45/30
450 X 400	DT07/45/40
500 X 300	DT07/50/30
500 X 400	DT07/50/40
600 X 300	DT07/60/30
600 X 400	DT07/60/40

3. Freestanding Dividers



D x H (mm)	Product Code
300 x 175	DT06/30/175
362 x 175	DT06/36/175
400 x 175	DT06/40/175
450 x 175	DT06/45/175
500 x 175	DT06/50/175
600 x 175	DT06/60/175

4. Bin Front



W x H (mm)	Product Code
686 X 85	DT09/07/85
902 X 85	DT09/09/85
986 X 85	DT09/10/85

5. Base Plinth



W x H (mm)	Product Code
686 x 25	DT10/07/25
902 x 25	DT10/09/25
986 x 25	DT10/10/25

Back Cladding sets

H x W (mm)	Product Code
1930 X 686	DT05/1907/WH
1930 x 902	DT05/1909/WH
1930 X 986	DT05/1910/WH
2230 X 686	DT05/2207/WH
2230 x 902	DT05/2209/WH
2230 X 986	DT05/2210/WH
2530 X 686	DT05/2507/WH
2530 x 902	DT05/2509/WH
2530 X 986	DT05/2510/WH

Lateral filing option requires 362mm deep plain shelves. Slotted shelves can be substituted for plain shelves on request





Anco Storage

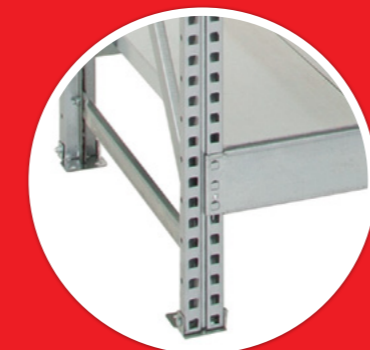

MIDISPAN RACKING

Midispan is our longspan shelving system with steel decking panels supplied in a contemporary pre-galvanised finish.

This makes it ideal for the most demanding applications and environments. The profiles are designed in such a way to ensure there are no sharp edges when assembling or in use.

The system has a wide range of profiles and sizes which provides complete flexibility when designing your warehouse. Along with a range of accessories that make it simple to store many different products as well as bespoke solutions for the automotive industry.

We offer guaranteed delivery within 5 days, including components to build a high bay or multi-tier installation from our large stocks.

- Heavy duty and secure
- Easy to build and reconfigure
- Beams adjust every 25mm
- Guaranteed delivery in 5 days
- Available in blue or galvanised uprights
- Galvanised beams and decking panels

Industrial Galvanised Racking



Detail of C50 beam on M50 upright

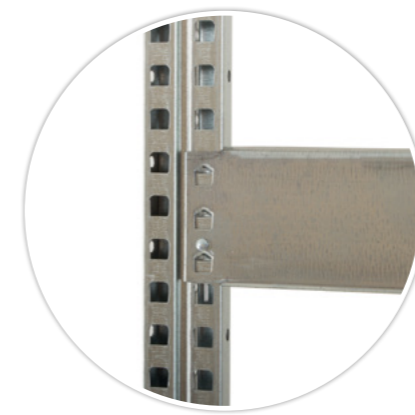

Detail of C70 beam on M50 upright



Heights

Standard Bay Heights (mm)
M50 Profile
1950, 2550, 3000

M70 Profile
2550, 4500, 5550, 6000



Widths

Widths (mm)
C50 Beams
1000, 1200, 1600

C70 Beams
1000, 1200, 1600, 1800,
2000, 2400

C100 Box Beams
1600, 1800, 2000, 2400



Depths

Depths (mm)
400, 600, 800,
1000, 1200



Application

Environment
Warehouse, Storeroom,
Workshop

Usage
Heavy Duty Storage



Construction

Uprights: **Steel**
Galvanised

C50 & C70 Beams: **Steel**
Galvanised

C100 Beams: **Steel**
Grey RAL7037

Shelves: **Steel**
Galvanised Panels



Loadings

Shelf UDL up to
2500kg

M50 Max Bay Load
4400kg

M70 Max Bay Load
8800kg

Contact sales office
for complete loading info.

Anco Storage



Design and plan your Midispan Racking layout

C50 Loadings	
Length (mm)	UDL (kgs)
800	400
1000	400
1200	340
1400	290
1600	250
1800	220
Load per pair	

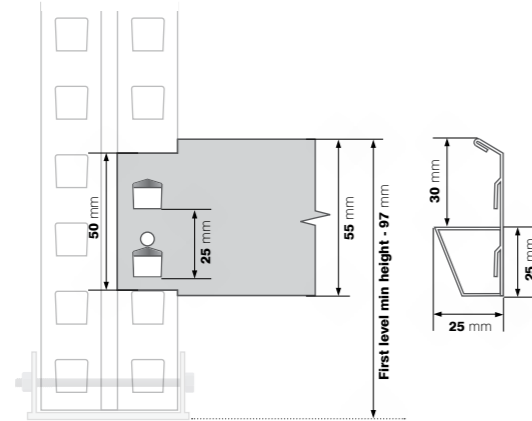

C70 Loadings	
Length (mm)	UDL (kgs)
800	1000
1000	1000
1200	930
1400	840
1600	750
1800	660
2000	600
2200	540
2400	480
Load per pair	

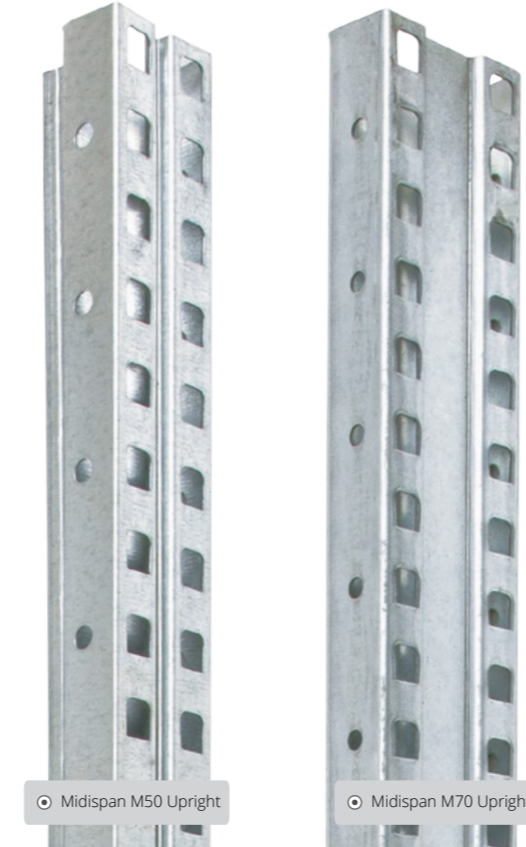
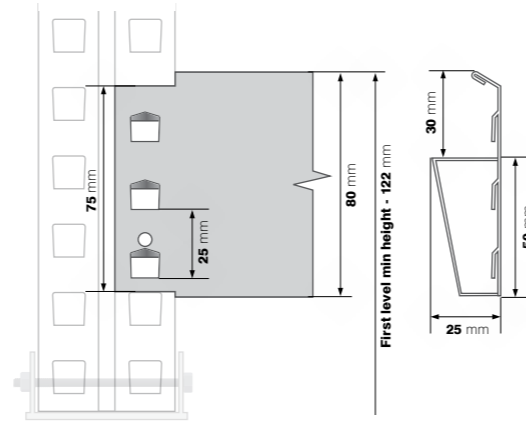

Midispan M50 Upright

Midispan M70 Upright

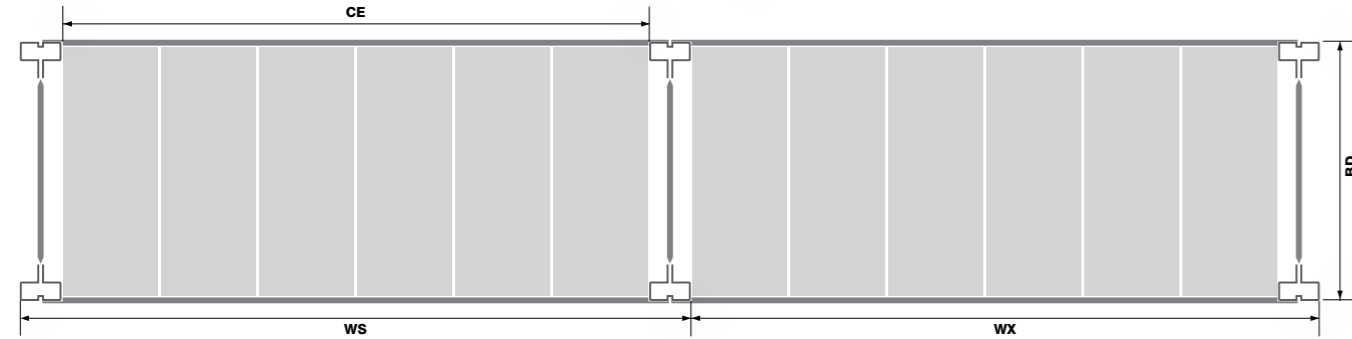

Depths (mm)		Widths (mm)				
Nominal Depth (List Measurement)	BD (Bay Depth)	Width using M50 Upright		Width using M70 Upright		CE (Clear Entry)
		WS (Starter Bay)	WX (Extension Bay)	WS (Starter Bay)	WX (Extension Bay)	
400	402	800	900	850	940	800
500	502	1000	1100	1050	1140	1000
600	602	1200	1300	1250	1340	1200
700	702	1400	1500	1450	1470	1400
800	802	1600	1700	1650	1740	1600
1000	1002	1800	1900	1850	1940	1800
1200	1202	2000	2100	2050	2140	2000
		2200	2300	2250	2340	2200
		2400	2500	2450	2540	2400
		2700	2800	2750	2840	2700
Load per pair						

Midispan Starter and Extension Bays

1950mm High Bays with M50 Frames & 3 x C70 Shelf Levels per Bay				
Bay Size (HxWxD)	Starter Bays	Extension Bays	Extra Levels	Shelf UDL
	Code	Code	Code	
1950x1000x400mm	MSBS/191004/3/M50/C70/GV	MSBE/191004/3/M50/C70/GV	MSB/1004C70/GV	500kg
1950x1200x400mm	MSBS/191204/3/M50/C70/GV	MSBE/191204/3/M50/C70/GV	MSB/1204C70/GV	600kg
1950x1600x400mm	MSBS/191604/3/M50/C70/GV	MSBE/191604/3/M50/C70/GV	MSB/1604C70/GV	750kg
1950x1800x400mm	MSBS/191804/3/M50/C70/GV	MSBE/191804/3/M50/C70/GV	MSB/1804C70/GV	660kg
1950x2000x400mm	MSBS/192004/3/M50/C70/GV	MSBE/192004/3/M50/C70/GV	MSB/2004C70/GV	600kg
1950x2400x400mm	MSBS/192404/3/M50/C70/GV	MSBE/192404/3/M50/C70/GV	MSB/2404C70/GV	480kg
1950x1000x600mm	MSBS/191006/3/M50/C70/GV	MSBE/191006/3/M50/C70/GV	MSB/1006C70/GV	450kg
1950x1200x600mm	MSBS/191206/3/M50/C70/GV	MSBE/191206/3/M50/C70/GV	MSB/1206C70/GV	540kg
1950x1600x600mm	MSBS/191606/3/M50/C70/GV	MSBE/191606/3/M50/C70/GV	MSB/1606C70/GV	720kg
1950x1800x600mm	MSBS/191806/3/M50/C70/GV	MSBE/191806/3/M50/C70/GV	MSB/1806C70/GV	660kg
1950x2000x600mm	MSBS/192006/3/M50/C70/GV	MSBE/192006/3/M50/C70/GV	MSB/2006C70/GV	600kg
1950x2400x600mm	MSBS/192406/3/M50/C70/GV	MSBE/192406/3/M50/C70/GV	MSB/2406C70/GV	480kg
1950x1000x800mm	MSBS/191008/3/M50/C70/GV	MSBE/191008/3/M50/C70/GV	MSB/1008C70/GV	400kg
1950x1200x800mm	MSBS/191208/3/M50/C70/GV	MSBE/191208/3/M50/C70/GV	MSB/1208C70/GV	480kg
1950x1600x800mm	MSBS/191608/3/M50/C70/GV	MSBE/191608/3/M50/C70/GV	MSB/1608C70/GV	640kg
1950x1800x800mm	MSBS/191808/3/M50/C70/GV	MSBE/191808/3/M50/C70/GV	MSB/1808C70/GV	660kg
1950x2000x800mm	MSBS/192008/3/M50/C70/GV	MSBE/192008/3/M50/C70/GV	MSB/2008C70/GV	600kg
1950x2400x800mm	MSBS/192408/3/M50/C70/GV	MSBE/192408/3/M50/C70/GV	MSB/2408C70/GV	480kg
1950x1000x1000mm	MSBS/191010/3/M50/C70/GV	MSBE/191010/3/M50/C70/GV	MSB/1010C70/GV	350kg
1950x1200x1000mm	MSBS/191210/3/M50/C70/GV	MSBE/191210/3/M50/C70/GV	MSB/1210C70/GV	420kg
1950x1600x1000mm	MSBS/191610/3/M50/C70/GV	MSBE/191610/3/M50/C70/GV	MSB/1610C70/GV	560kg
1950x1800x1000mm	MSBS/191810/3/M50/C70/GV	MSBE/191810/3/M50/C70/GV	MSB/1810C70/GV	630kg
1950x2000x1000mm	MSBS/192010/3/M50/C70/GV	MSBE/192010/3/M50/C70/GV	MSB/2010C70/GV	600kg
1950x2400x1000mm	MSBS/192410/3/M50/C70/GV	MSBE/192410/3/M50/C70/GV	MSB/2410C70/GV	480kg
1950x1000x1200mm	MSBS/191012/3/M50/C70/GV	MSBE/191012/3/M50/C70/GV	MSB/1012C70/GV	325kg
1950x1200x1200mm	MSBS/191212/3/M50/C70/GV	MSBE/191212/3/M50/C70/GV	MSB/1212C70/GV	390kg
1950x1600x1200mm	MSBS/191612/3/M50/C70/GV	MSBE/191612/3/M50/C70/GV	MSB/1612C70/GV	520kg
1950x1800x1200mm	MSBS/191812/3/M50/C70/GV	MSBE/191812/3/M50/C70/GV	MSB/1812C70/GV	585kg
1950x2000x1200mm	MSBS/192012/3/M50/C70/GV	MSBE/192012/3/M50/C70/GV	MSB/2012C70/GV	600kg
1950x2400x1200mm	MSBS/192412/3/M50/C70/GV	MSBE/192412/3/M50/C70/GV	MSB/2412C70/GV	480kg

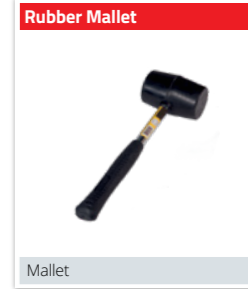

Mallet



MS7/M50SHIM



MS7/M70SHIM



FFM8/70 M8x65mm

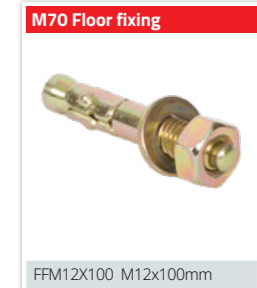

FFM12X100 M12x100mm



Midspan Racking's automotive solutions



Standard Midspan Tyre Racks use 400mm deep frames



Exhaust hangers & other automotive accessories available to order.

C70 Tyre Racking Levels (For frames see p.69)

W x D (mm)	Code	Shelf Load (kg)
1000mm	MSB/10C70	1000
1200mm	MSB/12C70	930
1600mm	MSB/16C70	750
1800mm	MSB/18C70	660
2000mm	MSB/20C70	600
2400mm	MSB/24C70	480

Includes pair of beams and safety pins. No decking included!

C100 Profile Box Beam Levels (For frames see p.69 (RAL7037))

W (mm)	Code	Shelf Load (kg)
1600mm	MSB/16C100B	2500kgs
1800mm	MSB/18C100B	2500kgs
2000mm	MSB/20C100B	2330kgs
2400mm	MSB/24C100B	2330kgs

Includes pair of beams and safety pins. Accessories not included.

Now available in frames up to 6000mm high

Frames - M50 Profile - Galvanised (Frame capacity up to 4300kg*)

H (mm)	Code	Code	Code	Code	Code
1950mm	MSF/19/04	MSF/19/06	MSF/19/08	MSF/19/10	MSF/19/12
2550mm	MSF/25/04	MSF/25/06	MSF/25/08	MSF/25/10	MSF/25/12
3000mm	MSF/30/04	MSF/30/06	MSF/30/08	MSF/30/10	MSF/30/12

Frames - M70 Profile - Galvanised (Frame capacity up to 8800kg*)

2550mm	-	MSF70/25/06	MSF70/25/08	MSF70/25/10	MSF70/25/12
4500mm	-	MSF70/45/06	MSF70/45/08	MSF70/45/10	MSF70/45/12
5550mm	-	MSF70/55/06	MSF70/55/08	MSF70/55/10	MSF70/55/12
6000mm	-	MSF70/60/06	MSF70/60/08	MSF70/60/10	MSF70/60/12

Includes uprights, metal feet and all necessary bracing and fixings (M50 = M8x50 or M8x70, M70 = M12x100).
*Frame capacity based on shelf levels spaced at 400mm intervals.

M70 Shim (100x100x1.2mm)



MS7/M70SHIM

Floor Fixing

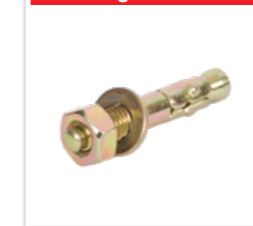

FFM8/70 M8x65mm

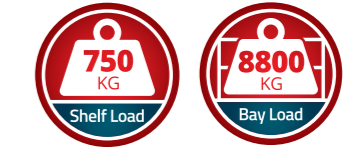

Midspan 1950 x 1800 x 600 on M50 profile frame and C70 beams with galvanised decking +detail on metal feet

C50 Profile Galvanised Beam Levels - Including All Galvanised Decking

W (mm)	Depth - 400mm		Depth - 600mm		Depth - 800mm		Depth - 1000mm		Depth - 1200mm	
	Code	Shelf Load	Code	Shelf Load	Code	Shelf Load	Code	Shelf Load	Code	Shelf Load
1000mm	MSB/1004C50/GV	400	MSB/1006C50/GV	400	MSB/1008C50/GV	400	MSB/1010C50/GV	350	MSB/1012C50/GV	325
1200mm	MSB/1204C50/GV	340	MSB/1206C50/GV	340	MSB/1208C50/GV	340	MSB/1210C50/GV	340	MSB/1212C50/GV	340
1600mm	MSB/1604C50/GV	250	MSB/1606C50/GV	250	MSB/1608C50/GV	250	MSB/1610C50/GV	250	MSB/1612C50/GV	250

C70 Profile Galvanised Beam Levels - Including All Galvanised Decking

1000mm	MSB/1004C70/GV	500	MSB/1006C70/GV	450	MSB/1008C70/GV	400	MSB/1010C70/GV	350	MSB/1012C70/GV	325
1200mm	MSB/1204C70/GV	600	MSB/1206C70/GV	540	MSB/1208C70/GV	480	MSB/1210C70/GV	420	MSB/1212C70/GV	390
1600mm	MSB/1604C70/GV	750	MSB/1606C70/GV	720	MSB/1608C70/GV	640	MSB/1610C70/GV	560	MSB/1612C70/GV	520
1800mm	MSB/1804C70/GV	660	MSB/1806C70/GV	660	MSB/1808C70/GV	660	MSB/1810C70/GV	630	MSB/1812C70/GV	585
2000mm	MSB/2004C70/GV	600	MSB/2006C70/GV	600	MSB/2008C70/GV	600	MSB/2010C70/GV	600	MSB/2012C70/GV	600
2400mm	MSB/2404C70/GV	480	MSB/2406C70/GV	480	MSB/2408C70/GV	480	MSB/2410C70/GV	480	MSB/2412C70/GV	480

Includes pair of beams, galvanised decking, safety pins and beam ties.





TS LONGSPAN RACKING

If you need a strong, robust and versatile solution, at a competitive price – then look no further.

The unique fit between the upright and claw gives our longspan racking incredible strength and rigidity. Along with our heavy duty "Z profile" beam which ensures it will meet the most rigorous demands.

All levels come with heavy duty deck supports as standard, this ensures the chipboard & steel mesh shelves carry the same load as the beams. The unique deck support slots into the beam which also eliminates the beams spreading or rotating.

- **Heavy duty Racking system**
Store all your heavy and bulk items with ease
- **Adaptable storage solutions**
Simple to add to, as your storage needs grow
- **Strong "Z" profile beam design**
Unique beam design that offers capacities up to 950kgs
- **Heavy duty shelf levels**
Shelf levels includes deck supports to match beam capacities
- **Guaranteed delivery in 5 days**
Get your stores organised quickly with no hassle

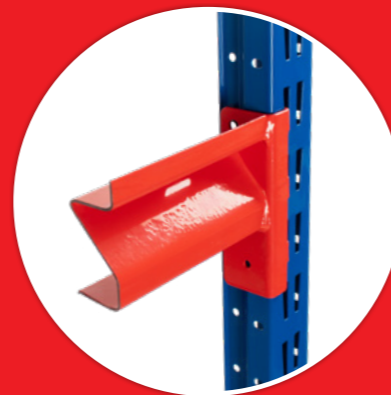

Extremely strong, heavy duty system that's easy to build



2754mm Beam



Heights

Standard Bay Height (mm)
1984, 2492, 3000,
3508, 4016



Widths

Widths (mm)
1229, 1534, 1839,
2144, 2449, 2754



Depths

Depths (mm)
471, 624, 776,
928, 1233



Application

Environment
Warehouse, Storeroom

Usage
Heavy Duty Racking



Construction

Frames: **Steel**
Blue RAL5010

Beams: **Steel**
Orange RAL2002

Shelves:
Chipboard Decking
Steel Mesh Decking
Solid Steel Decking



Loadings

Shelf UDL up to
950kg

Max Bay Load
3900kg



Design and plan your TS Longspan Racking layout

Calculating Exact Dimensions of the Bay & Run of Bays

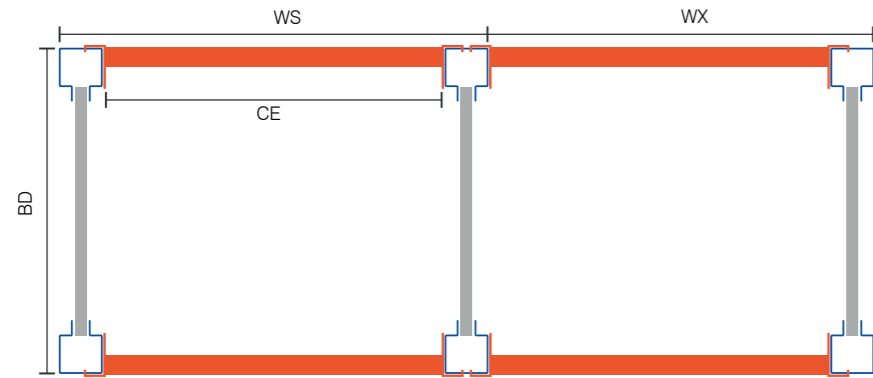

..add 3mm to dimension BD for each claw

Nominal Depth	BD Bay Depth	Nominal Width (W)	CE Clear Entry	WS Starter Bay	WX Extension Bay
471mm	471mm	1229mm	1229mm	1349mm	1289mm
624mm	624mm	1534mm	1534mm	1654mm	1594mm
776mm	776mm	1839mm	1839mm	1959mm	1899mm
928mm	928mm	2144mm	2144mm	2264mm	2204mm
1233mm	1233mm	2449mm	2449mm	2569mm	2509mm
		2754mm	2754mm	2874mm	2814mm

Add 10mm to over BD for footplate
Add 10mm to overall run length for footplate

Longspan Upright

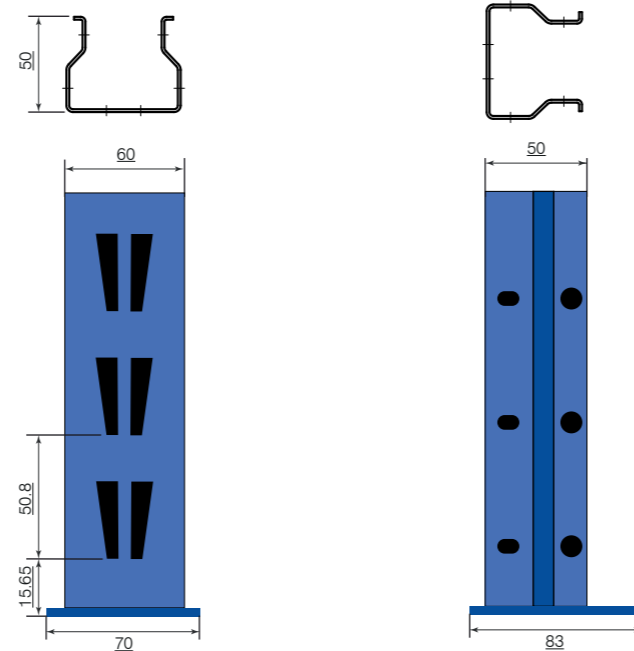

Longspan Bay Loading (kgs)

Maximum bay load (kg)	600	700	800	900	1000	1100	1200
4100							
3900	3900						
3700		3700					
3500			3500				
3300				3300			
3100					3100		
2900						2900	
2700							2700

Distance between levels (mm)

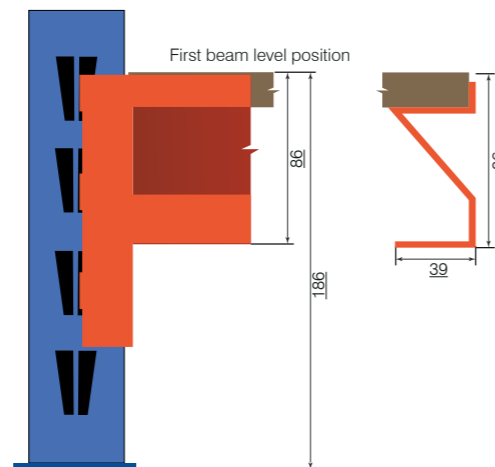

Longspan Footplate

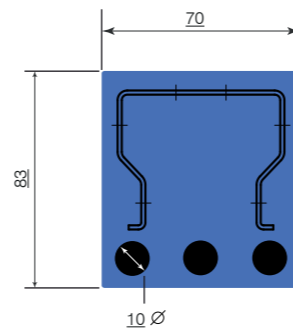

TS Longspan Heavy Duty Racking

If you need a strong, robust and versatile solution, at a competitive price – then look no further.

The unique fit between the upright and claw gives our longspan racking incredible strength and rigidity. Along with our heavy duty "Z profile" beam which ensures it will meet the most rigorous demands.

All levels come with heavy duty deck supports as standard (except 471mm deep). This ensures the chipboard, solid steel and wire mesh shelves carry the same load as the beams. The unique deck support slots into the beam which also eliminates the beams spreading or rotating.

- **"Twin Slot" pattern on the upright**
New larger upright profile 60x50mm with twin slots
- **Heavy duty Racking system**
Store all your heavy and bulk items with ease
- **Adaptable storage solutions**
Simple to add to, as your storage needs grow
- **Strong "Z" profile beam design**
Unique beam design that offers capacities up to 950kgs
- **Heavy duty shelf levels**
Shelf levels includes deck supports to match beam capacities
- **Guaranteed delivery in 5 days**
Get your stores organised quickly with no hassle



Deck supports are supplied on Depth's of 610mm and greater.

Shim	Floor Fixing	Plastic Top Cap
TS07/SHIM 87x70x1.2mm	FFM8/70 M8x65mm	TS07/TC 60x50mm



Best for Warehouse or Storeroom | up to 950kg UDL/shelf

TS Longspan Racking Frames & Levels

Frames		Levels	Levels	Beam Levels - Chipboard Decking		Levels	Beam Levels - Steel Decking	
H x D(mm)	Code	W x D(mm)	Code	Load (kg)	Deck Supports	Code	Load (kg)	Deck Supports
1984 x 471mm	TSF/20/04/BE	1229 x 471mm	TSB/12/04/OR	950	0	TSBSD/12/04/OR	480	0
2492 x 471mm	TSF/25/04/BE	1534 x 471mm	TSB/15/04/OR	850	0	TSBSD/15/04/OR	600	0
3000 x 471mm	TSF/30/04/BE	1839 x 471mm	TSB/18/04/OR	800	0	TSBSD/18/04/OR	720	0
3508 x 471mm	TSF/35/04/BE	2144 x 471mm	TSB/21/04/OR	700	0	TSBSD/21/04/OR	700	0
4016 x 471mm	TSF/40/04/BE	2449 x 471mm	TSB/24/04/OR	600	0	TSBSD/24/04/OR	600	0
		2754 x 471mm	TSB/27/04/OR	440	0	TSBSD/27/04/OR	440	0
1984 x 624mm	TSF/20/06/BE	1229 x 624mm	TSB/12/06/OR	900	3	TSBSD/12/06/OR	480	2
2492 x 624mm	TSF/25/06/BE	1534 x 624mm	TSB/15/06/OR	800	3	TSBSD/15/06/OR	600	2
3000 x 624mm	TSF/30/06/BE	1839 x 624mm	TSB/18/06/OR	800	3	TSBSD/18/06/OR	720	2
3508 x 624mm	TSF/35/06/BE	2144 x 624mm	TSB/21/06/OR	700	3	TSBSD/21/06/OR	700	2
4016 x 624mm	TSF/40/06/BE	2449 x 624mm	TSB/24/06/OR	600	4	TSBSD/24/06/OR	600	2
		2754 x 624mm	TSB/27/06/OR	440	5	TSBSD/27/06/OR	440	2
1984 x 776mm	TSF/20/07/BE	1229 x 776mm	TSB/12/07/OR	875	3	TSBSD/12/07/OR	480	2
2492 x 776mm	TSF/25/07/BE	1534 x 776mm	TSB/15/07/OR	775	3	TSBSD/15/07/OR	600	2
3000 x 776mm	TSF/30/07/BE	1839 x 776mm	TSB/18/07/OR	800	3	TSBSD/18/07/OR	720	2
3508 x 776mm	TSF/35/07/BE	2144 x 776mm	TSB/21/07/OR	700	4	TSBSD/21/07/OR	700	2
4016 x 776mm	TSF/40/07/BE	2449 x 776mm	TSB/24/07/OR	575	4	TSBSD/24/07/OR	600	2
		2754 x 776mm	TSB/27/07/OR	440	5	TSBSD/27/07/OR	440	2
1984 x 928mm	TSF/20/09/BE	1229 x 928mm	TSB/12/09/OR	825	3	TSBSD/12/09/OR	400	2
2492 x 928mm	TSF/25/09/BE	1534 x 928mm	TSB/15/09/OR	725	3	TSBSD/15/09/OR	500	2
3000 x 928mm	TSF/30/09/BE	1839 x 928mm	TSB/18/09/OR	800	3	TSBSD/18/09/OR	600	2
3508 x 928mm	TSF/35/09/BE	2144 x 928mm	TSB/21/09/OR	675	4	TSBSD/21/09/OR	700	2
4016 x 928mm	TSF/40/09/BE	2449 x 928mm	TSB/24/09/OR	550	4	TSBSD/24/09/OR	600	2
		2754 x 928mm	TSB/27/09/OR	440	5	TSBSD/27/09/OR	440	2
1984 x 1233mm	TSF/20/12/BE	1229 x 1233mm	TSB/12/12/OR	750	3	TSBSD/12/12/OR	360	2
2492 x 1233mm	TSF/25/12/BE	1534 x 1233mm	TSB/15/12/OR	675	3	TSBSD/15/12/OR	450	2
3000 x 1233mm	TSF/30/12/BE	1839 x 1233mm	TSB/18/12/OR	750	3	TSBSD/18/12/OR	540	2
3508 x 1233mm	TSF/35/12/BE	2144 x 1233mm	TSB/21/12/OR	625	5	TSBSD/21/12/OR	630	2
4016 x 1233mm	TSF/40/12/BE	2449 x 1233mm	TSB/24/12/OR	525	5	TSBSD/24/12/OR	600	2
		2754 x 1233mm	TSB/27/12/OR	440	5	TSBSD/27/12/OR	440	2

① **Frame** includes 2x uprights with all necessary bracing and fixings – requires self assembly. **Beam level** is one complete level that includes 2x beams, (Chipboard, Solid Steel or Wire Mesh Decking) all necessary deck supports and safety pins. (Floor Fixings 'M8x65' / 'M8x70' available on request) **Remember, if your shelving's height to depth ratio is greater than 4:1, the bay should be fixed to the floor or to the wall!**



TS Longspan Racking Chipboard Decking

Starter Bay - Chipboard decking		Extension Bay - Chipboard Decking		Extra Levels - Chipboard Decking	
Size (HxWxD) mm	Code	Code	Code	Level Code	Load(kg)
1984 x 1229 x 471	TNBS/201204/3/BO	TNBE/201204/3/BO	TSB/12/04/OR	950	
1984 x 1534 x 471	TNBS/201504/3/BO	TNBE/201504/3/BO	TSB/15/04/OR	850	
1984 x 1839 x 471	TNBS/201804/3/BO	TNBE/201804/3/BO	TSB/18/04/OR	800	
1984 x 2144 x 471	TNBS/202104/3/BO	TNBE/202104/3/BO	TSB/21/04/OR	700	
1984 x 2449 x 471	TNBS/202404/3/BO	TNBE/202404/3/BO	TSB/24/04/OR	600	
1984 x 2754 x 471	TNBS/202704/3/BO	TNBE/202704/3/BO	TSB/27/04/OR	440	
1984 x 1229 x 624	TNBS/201206/3/BO	TNBE/201206/3/BO	TSB/12/06/OR	900	
1984 x 1534 x 624	TNBS/201506/3/BO	TNBE/201506/3/BO	TSB/15/06/OR	800	
1984 x 1839 x 624	TNBS/201806/3/BO	TNBE/201806/3/BO	TSB/18/06/OR	800	
1984 x 2144 x 624	TNBS/202106/3/BO	TNBE/202106/3/BO	TSB/21/06/OR	700	
1984 x 2449 x 624	TNBS/202406/3/BO	TNBE/202406/3/BO	TSB/24/06/OR	600	
1984 x 2754 x 624	TNBS/202706/3/BO	TNBE/202706/3/BO	TSB/27/06/OR	440	
1984 x 1229 x 776	TNBS/201207/3/BO	TNBE/201207/3/BO	TSB/12/07/OR	875	
1984 x 1534 x 776	TNBS/201507/3/BO	TNBE/201507/3/BO	TSB/15/07/OR	775	
1984 x 1839 x 776	TNBS/201807/3/BO	TNBE/201807/3/BO	TSB/18/07/OR	800	
1984 x 2144 x 776	TNBS/202107/3/BO	TNBE/202107/3/BO	TSB/21/07/OR	700	
1984 x 2449 x 776	TNBS/202407/3/BO	TNBE/202407/3/BO	TSB/24/07/OR	575	
1984 x 2754 x 776	TNBS/202707/3/BO	TNBE/202707/3/BO	TSB/27/07/OR	440	
1984 x 1229 x 928	TNBS/201209/3/BO	TNBE/201209/3/BO	TSB/12/09/OR	825	
1984 x 1534 x 928	TNBS/201509/3/BO	TNBE/201509/3/BO	TSB/15/09/OR	725	
1984 x 1839 x 928	TNBS/201809/3/BO	TNBE/201809/3/BO	TSB/18/09/OR	800	
1984 x 2144 x 928	TNBS/202109/3/BO	TNBE/202109/3/BO	TSB/21/09/OR	675	
1984 x 2449 x 928	TNBS/202409/3/BO	TNBE/202409/3/BO	TSB/24/09/OR	550	
1984 x 2754 x 928	TNBS/202709/3/BO	TNBE/202709/3/BO	TSB/27/09/OR	440	
1984 x 1229 x 1233	TNBS/201212/3/BO	TNBE/201212/3/BO	TSB/12/12/OR	750	
1984 x 1534 x 1233	TNBS/201512/3/BO	TNBE/201512/3/BO	TSB/15/12/OR	675	
1984 x 1839 x 1233	TNBS/201812/3/BO	TNBE/201812/3/BO	TSB/18/12/OR	750	
1984 x 2144 x 1233	TNBS/202112/3/BO	TNBE/202112/3/BO	TSB/21/12/OR	625	
1984 x 2449 x 1233	TNBS/202412/3/BO	TNBE/202412/3/BO	TSB/24/12/OR	525	
1984 x 2754 x 1233	TNBS/202712/3/BO	TNBE/202712/3/BO	TSB/27/12/OR	440	

① Starter includes 2x Frame and 3x Beam Levels. Extension includes 1x Frame and 3x Beam Levels. Frame includes 2x uprights with all necessary bracing and fixings (Assembly Required). Beam level includes 2x beams, chipboard decking, all necessary deck supports and safety pins. **To configure your own bay with a selection of frames and beams, turn to page 5**



Extra Height - 471mm deep		Extra Height - 624mm deep		Extra Height - 776mm deep		Extra Height - 928mm deep		Extra Height - 1233mm deep	
H x D(mm)	Code	H x D(mm)	Code	H x D(mm)	Code	H x D(mm)	Code	H x D(mm)	Code
2492 x 471	---/25-04/3/BO	2492 x 624	---/25-06/3/BO	2492 x 776	---/25-07/3/BO	2492 x 928	---/25-09/3/BO	2492 x 1233	---/25-12/3/BO
3000 x 471	---/30-04/3/BO	3000 x 624	---/30-06/3/BO	3000 x 776	---/30-07/3/BO	3000 x 928	---/30-09/3/BO	3000 x 1233	---/30-12/3/BO
3508 x 471	---/35-04/3/BO	3508 x 624	---/35-06/3/BO	3508 x 776	---/35-07/3/BO	3508 x 928	---/35-09/3/BO	3508 x 1233	---/35-12/3/BO
4016 x 471	---/40-04/3/BO	4016 x 624	---/40-06/3/BO	4016 x 776	---/40-07/3/BO	4016 x 928	---/40-09/3/BO	4016 x 1233	---/40-12/3/BO

TS LONGSPAN CHIPBOARD DECKING



TS Longspan Racking Solid Steel Decking

Starter Bay - Solid steel decking **Extension Bay - Solid Steel Decking** **Extra Levels - Solid Steel Decking**

Size (HxWxD) mm	Code	Code	Level Code	Load(kg)
1984 x 1229 x 471	TNBSSD/201204/3/BO	TNBESD/201204/3/BO	TSBSD/12/04/OR	480
1984 x 1534 x 471	TNBSSD/201504/3/BO	TNBESD/201504/3/BO	TSBSD/15/04/OR	600
1984 x 1839 x 471	TNBSSD/201804/3/BO	TNBESD/201804/3/BO	TSBSD/18/04/OR	720
1984 x 2144 x 471	TNBSSD/202104/3/BO	TNBESD/202104/3/BO	TSBSD/21/04/OR	700
1984 x 2449 x 471	TNBSSD/202404/3/BO	TNBESD/202404/3/BO	TSBSD/24/04/OR	600
1984 x 2754 x 471	TNBSSD/202704/3/BO	TNBESD/202704/3/BO	TSBSD/27/04/OR	440
1984 x 1229 x 624	TNBSSD/201206/3/BO	TNBESD/201206/3/BO	TSBSD/12/06/OR	480
1984 x 1534 x 624	TNBSSD/201506/3/BO	TNBESD/201506/3/BO	TSBSD/15/06/OR	600
1984 x 1839 x 624	TNBSSD/201806/3/BO	TNBESD/201806/3/BO	TSBSD/18/06/OR	720
1984 x 2144 x 624	TNBSSD/202106/3/BO	TNBESD/202106/3/BO	TSBSD/21/06/OR	700
1984 x 2449 x 624	TNBSSD/202406/3/BO	TNBESD/202406/3/BO	TSBSD/24/06/OR	600
1984 x 2754 x 624	TNBSSD/202706/3/BO	TNBESD/202706/3/BO	TSBSD/27/06/OR	440
1984 x 1229 x 776	TNBSSD/201207/3/BO	TNBESD/201207/3/BO	TSBSD/12/07/OR	480
1984 x 1534 x 776	TNBSSD/201507/3/BO	TNBESD/201507/3/BO	TSBSD/15/07/OR	600
1984 x 1839 x 776	TNBSSD/201807/3/BO	TNBESD/201807/3/BO	TSBSD/18/07/OR	720
1984 x 2144 x 776	TNBSSD/202107/3/BO	TNBESD/202107/3/BO	TSBSD/21/07/OR	700
1984 x 2449 x 776	TNBSSD/202407/3/BO	TNBESD/202407/3/BO	TSBSD/24/07/OR	600
1984 x 2754 x 776	TNBSSD/202707/3/BO	TNBESD/202707/3/BO	TSBSD/27/07/OR	440
1984 x 1229 x 928	TNBSSD/201209/3/BO	TNBESD/201209/3/BO	TSBSD/12/09/OR	400
1984 x 1534 x 928	TNBSSD/201509/3/BO	TNBESD/201509/3/BO	TSBSD/15/09/OR	500
1984 x 1839 x 928	TNBSSD/201809/3/BO	TNBESD/201809/3/BO	TSBSD/18/09/OR	600
1984 x 2144 x 928	TNBSSD/202109/3/BO	TNBESD/202109/3/BO	TSBSD/21/09/OR	700
1984 x 2449 x 928	TNBSSD/202409/3/BO	TNBESD/202409/3/BO	TSBSD/24/09/OR	600
1984 x 2754 x 928	TNBSSD/202709/3/BO	TNBESD/202709/3/BO	TSBSD/27/09/OR	440
1984 x 1229 x 1233	TNBSSD/201212/3/BO	TNBESD/201212/3/BO	TSBSD/12/12/OR	360
1984 x 1534 x 1233	TNBSSD/201512/3/BO	TNBESD/201512/3/BO	TSBSD/15/12/OR	450
1984 x 1839 x 1233	TNBSSD/201812/3/BO	TNBESD/201812/3/BO	TSBSD/18/12/OR	540
1984 x 2144 x 1233	TNBSSD/202112/3/BO	TNBESD/202112/3/BO	TSBSD/21/12/OR	630
1984 x 2449 x 1233	TNBSSD/202412/3/BO	TNBESD/202412/3/BO	TSBSD/24/12/OR	600
1984 x 2754 x 1233	TNBSSD/202712/3/BO	TNBESD/202712/3/BO	TSBSD/27/12/OR	440



① Starter includes 2x Frame and 3x Beam Levels. Extension includes 1x Frame and 3x Beam Levels. Frame includes 2x uprights with all necessary bracing and fixings. (Assembly Required) Beam level includes 2x beams, steel decking, all necessary deck supports and safety pins. To configure your own bay with a selection of frames and beams, turn to page 5

Extra Height - 471mm deep		Extra Height - 624mm deep		Extra Height - 776mm deep		Extra Height - 928mm deep		Extra Height - 1233mm deep	
H x D(mm)	Code	H x D(mm)	Code	H x D(mm)	Code	H x D(mm)	Code	H x D(mm)	Code
2492 x 471	---/25-04/3/BO	2492 x 624	---/25-06/3/BO	2492 x 776	---/25-07/3/BO	2492 x 928	---/25-09/3/BO	2492 x 1233	---/25-12/3/BO
3000 x 471	---/30-04/3/BO	3000 x 624	---/30-06/3/BO	3000 x 776	---/30-07/3/BO	3000 x 928	---/30-09/3/BO	3000 x 1233	---/30-12/3/BO
3508 x 471	---/35-04/3/BO	3508 x 624	---/35-06/3/BO	3508 x 776	---/35-07/3/BO	3508 x 928	---/35-09/3/BO	3508 x 1233	---/35-12/3/BO
4016 x 471	---/40-04/3/BO	4016 x 624	---/40-06/3/BO	4016 x 776	---/40-07/3/BO	4016 x 928	---/40-09/3/BO	4016 x 1233	---/40-12/3/BO

TS Longspan Racking Wire Mesh Decking

Starter Bay - Mesh decking **Extension Bay - Mesh Decking** **Extra Levels - Mesh Decking**

Size (HxWxD) mm	Code	Code	Level Code	Load(kg)
1984 x 1229 x 471	TNBSWD/201204/3/BO	TNBEWD/201204/3/BO	TSBWD/12/04/OR	350
1984 x 1534 x 471	TNBSWD/201504/3/BO	TNBEWD/201504/3/BO	TSBWD/15/04/OR	N/A
1984 x 1839 x 471	TNBSWD/201804/3/BO	TNBEWD/201804/3/BO	TSBWD/18/04/OR	700
1984 x 2144 x 471	TNBSWD/202104/3/BO	TNBEWD/202104/3/BO	TSBWD/21/04/OR	700
1984 x 2449 x 471	TNBSWD/202404/3/BO	TNBEWD/202404/3/BO	TSBWD/24/04/OR	600
1984 x 2754 x 471	TNBSWD/202704/3/BO	TNBEWD/202704/3/BO	TSBWD/27/04/OR	440
1984 x 1229 x 624	TNBSWD/201206/3/BO	TNBEWD/201206/3/BO	TSBWD/12/06/OR	350
1984 x 1534 x 624	TNBSWD/201506/3/BO	TNBEWD/201506/3/BO	TSBWD/15/06/OR	N/A
1984 x 1839 x 624	TNBSWD/201806/3/BO	TNBEWD/201806/3/BO	TSBWD/18/06/OR	700
1984 x 2144 x 624	TNBSWD/202106/3/BO	TNBEWD/202106/3/BO	TSBWD/21/06/OR	700
1984 x 2449 x 624	TNBSWD/202406/3/BO	TNBEWD/202406/3/BO	TSBWD/24/06/OR	600
1984 x 2754 x 624	TNBSWD/202706/3/BO	TNBEWD/202706/3/BO	TSBWD/27/06/OR	440
1984 x 1229 x 776	TNBSWD/201207/3/BO	TNBEWD/201207/3/BO	TSBWD/12/07/OR	325
1984 x 1534 x 776	TNBSWD/201507/3/BO	TNBEWD/201507/3/BO	TSBWD/15/07/OR	N/A
1984 x 1839 x 776	TNBSWD/201807/3/BO	TNBEWD/201807/3/BO	TSBWD/18/07/OR	650
1984 x 2144 x 776	TNBSWD/202107/3/BO	TNBEWD/202107/3/BO	TSBWD/21/07/OR	650
1984 x 2449 x 776	TNBSWD/202407/3/BO	TNBEWD/202407/3/BO	TSBWD/24/07/OR	600
1984 x 2754 x 776	TNBSWD/202707/3/BO	TNBEWD/202707/3/BO	TSBWD/27/07/OR	440
1984 x 1229 x 928	TNBSWD/201209/3/BO	TNBEWD/201209/3/BO	TSBWD/12/09/OR	300
1984 x 1534 x 928	TNBSWD/201509/3/BO	TNBEWD/201509/3/BO	TSBWD/15/09/OR	N/A
1984 x 1839 x 928	TNBSWD/201809/3/BO	TNBEWD/201809/3/BO	TSBWD/18/09/OR	600
1984 x 2144 x 928	TNBSWD/202109/3/BO	TNBEWD/202109/3/BO	TSBWD/21/09/OR	600
1984 x 2449 x 928	TNBSWD/202409/3/BO	TNBEWD/202409/3/BO	TSBWD/24/09/OR	600
1984 x 2754 x 928	TNBSWD/202709/3/BO	TNBEWD/202709/3/BO	TSBWD/27/09/OR	440
1984 x 1229 x 1233	TNBSWD/201212/3/BO	TNBEWD/201212/3/BO	TSBWD/12/12/OR	250
1984 x 1534 x 1233	TNBSWD/201512/3/BO	TNBEWD/201512/3/BO	TSBWD/15/12/OR	N/A
1984 x 1839 x 1233	TNBSWD/201812/3/BO	TNBEWD/201812/3/BO	TSBWD/18/12/OR	500
1984 x 2144 x 1233	TNBSWD/202112/3/BO	TNBEWD/202112/3/BO	TSBWD/21/12/OR	500
1984 x 2449 x 1233	TNBSWD/202412/3/BO	TNBEWD/202412/3/BO	TSBWD/24/12/OR	500
1984 x 2754 x 1233	TNBSWD/202712/3/BO	TNBEWD/202712/3/BO	TSBWD/27/12/OR	440



① Starter includes 2x Frame and 3x Beam Levels. Extension includes 1x Frame and 3x Beam Levels. Frame includes 2x uprights with all necessary bracing and fixings. (Assembly Required) Beam level includes 2x beams, mesh decking, all necessary deck supports and safety pins. To configure your own bay with a selection of frames and beams, turn to page 5

Extra Height - 471mm deep		Extra Height - 624mm deep		Extra Height - 776mm deep		Extra Height - 928mm deep		Extra Height - 1233mm deep	
H x D(mm)	Code	H x D(mm)	Code	H x D(mm)	Code	H x D(mm)	Code	H x D(mm)	Code
2492 x 471	---/25-04/3/BO	2492 x 624	---/25-06/3/BO	2492 x 776	---/25-07/3/BO	2492 x 928	---/25-09/3/BO	2492 x 1233	---/25-12/3/BO
3000 x 471	---/30-04/3/BO	3000 x 624	---/30-06/3/BO	3000 x 776	---/30-07/3/BO	3000 x 928	---/30-09/3/BO	3000 x 1233	---/30-12/3/BO
3508 x 471	---/35-04/3/BO	3508 x 624	---/35-06/3/BO	3508 x 776	---/35-07/3/BO	3508 x 928	---/35-09/3/BO	3508 x 1233	---/35-12/3/BO
4016 x 471	---/40-04/3/BO	4016 x 624	---/40-06/3/BO	4016 x 776	---/40-07/3/BO	4016 x 928	---/40-09/3/BO	4016 x 1233	---/40-12/3/BO



TS Longspan Divider System Compartment Storage

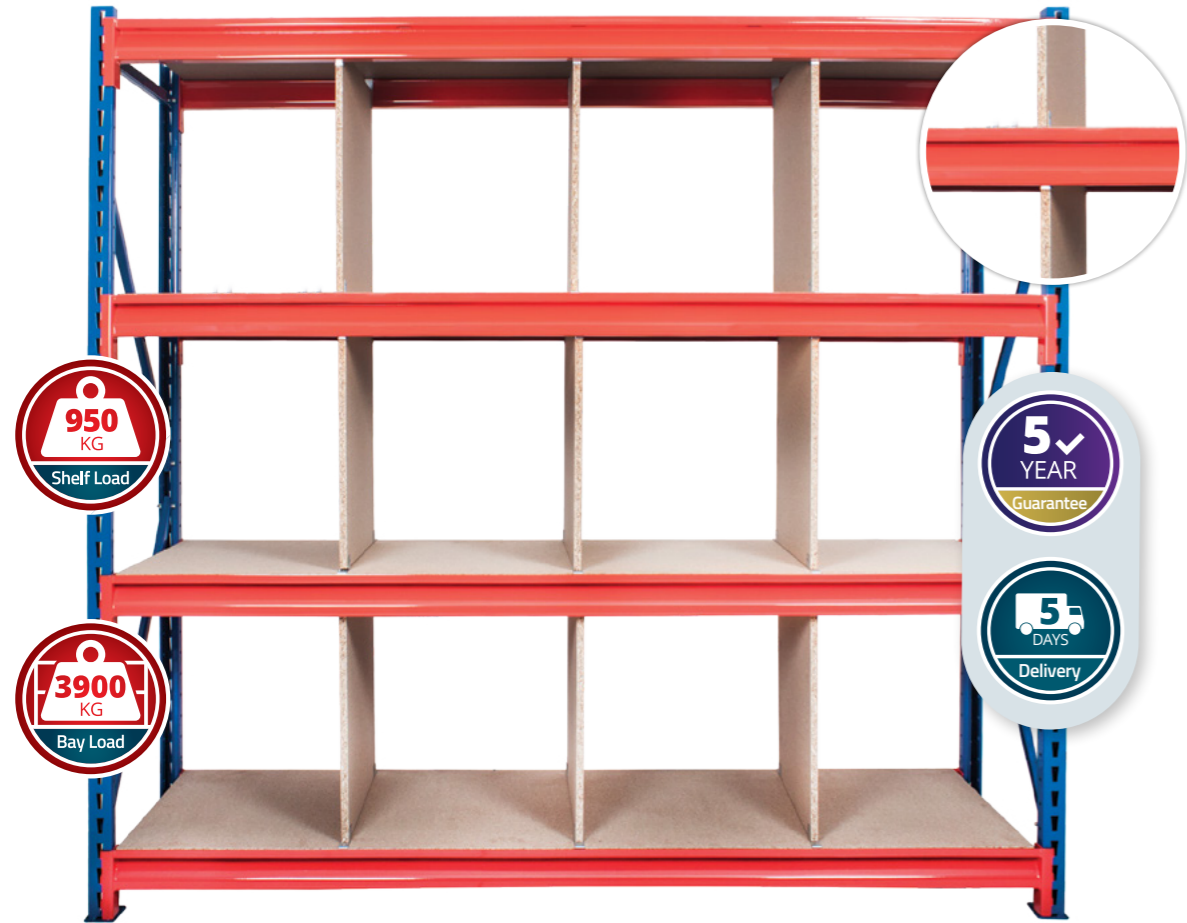

Longspan Divider System Starter Bays		Extension Bay	Extra Divider	
H x W x D (mm)	Code	Code	Code	Code
1984 x 1839 x 471	TNBS/201804/3/BO	TNBE/201804/3/BO	471 x 559	TSCD/04/559
1984 x 2144 x 471	TNBS/202104/3/BO	TNBE/202104/3/BO	471 x 559	TSCD/04/559
1984 x 2449 x 471	TNBS/202404/3/BO	TNBE/202404/3/BO	471 x 559	TSCD/04/559
1984 x 1839 x 624	TNBS/201806/3/BO	TNBE/201806/3/BO	624 x 559	TSCD/06/559
1984 x 2144 x 624	TNBS/202106/3/BO	TNBE/202106/3/BO	624 x 559	TSCD/06/559
1984 x 2449 x 624	TNBS/202406/3/BO	TNBE/202406/3/BO	624 x 559	TSCD/06/559

① can be made to suit any height or depth



① Fix divider to any position

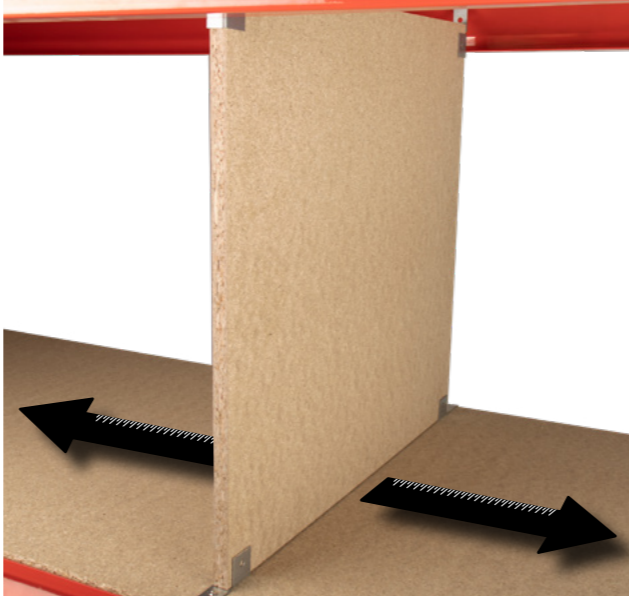

Shelf Bins & Additional Dividers

If you need a strong, robust and versatile bin storage solution, at a competitive price – then look no further.

Our new range of Shelf Bins have been designed to offer a range of bins in “Big Sizes” for storing large parts or increased volumes. They can fit both small parts shelving systems as well as larger bays, such as Rivet or Longspan.

They have many new features, such as internal dividers that securely locate into 7 different locations. There is also an integral back stop allowing the bin to be suspended out from the shelving, for ease of picking.

With a semi-open fronted and a large labelling area below, ensures items can be identified quickly. The bins are available in Blue shockproof plastic and can be nested when not in use to save space.

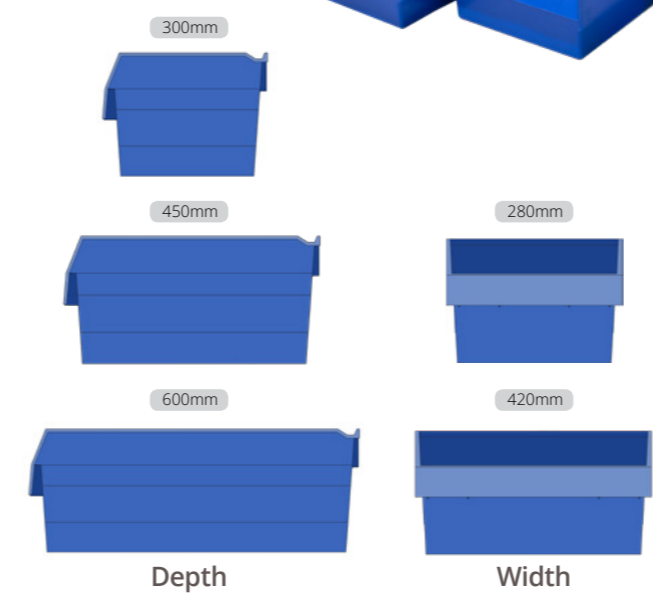

Shelf Bins		
D x W x H(mm)	Code	Colour
300x280x200mm	SFB302820	Blue
450x280x200mm	SFB452820	Blue
450x420x200mm	SFB454220	Blue
600x280x200mm	SFB602820	Blue
600x420x200mm	SFB604220	Blue

Add Dividers		
W x H(mm)	Code	Colour
280x200mm	SFD2820	Black
420x200mm	SFD4220	Black

Plastic Bin Features

- ① Integral back stop
- ② Profiled sides for extra strength
- ③ Nestable design – space saving
- ④ Large labelling area
- ⑤ Semi-open fronted design
- ⑥ 7 divider positions in each bin
- ⑦ Dividers positively slot into the bin



Automotive storage solutions with TS Longspan Racking

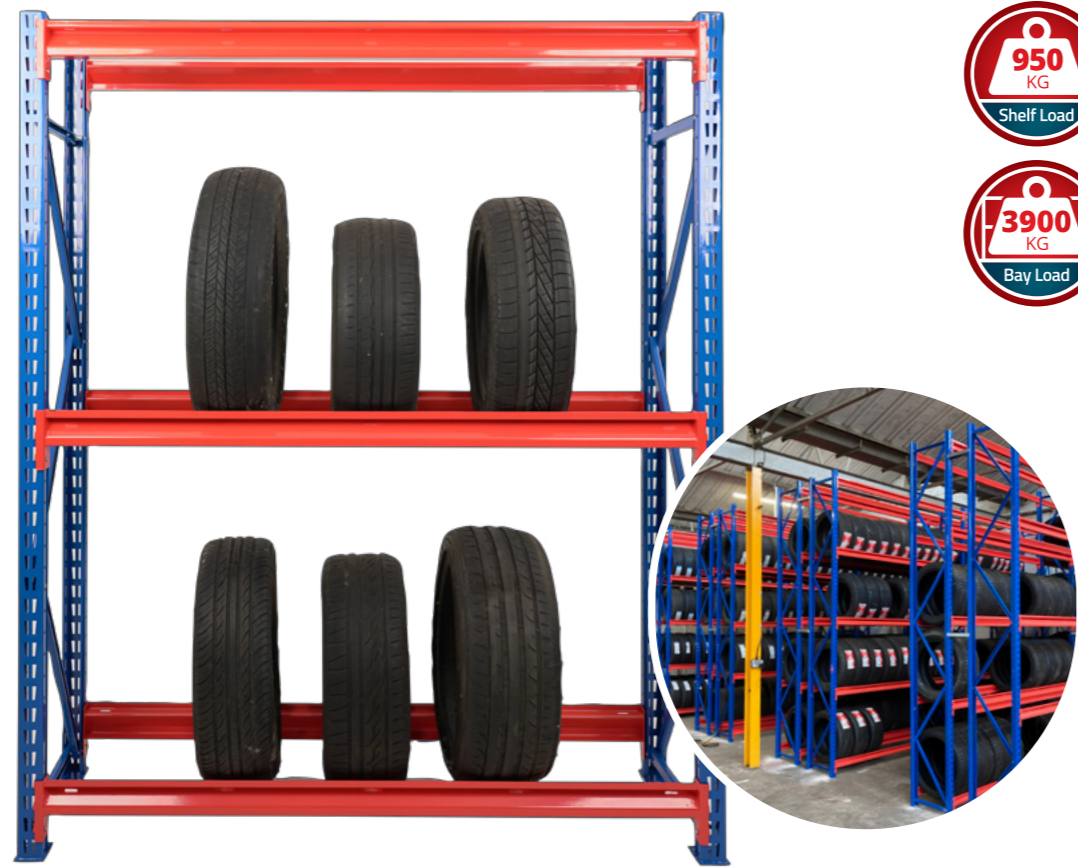

Standard TS Longspan Tyre Racks use 471mm deep frames

Tyre Racking Levels (For frames please see p.74)

Width (mm)	Code	Load UDL (kg) per Level
1229mm	TSBTR/12/OR	950
1534mm	TSBTR/15/OR	850
1839mm	TSBTR/18/OR	800
2144mm	TSBTR/21/OR	700
2449mm	TSBTR/24/OR	600
2754mm	TSBTR/27/OR	440

① Includes 2x beams and safety pins. No decking included / No frames.

Need more automotive solutions?

MIDSPAN RACKING

TURN TO **PAGE 60**

A heavy duty solution to a garment storage with TS Longspan



Longspan Centre Garment Rack

Longspan Double Sided Centre Garment Rack

Centre Garment Hanging Rail (For frames and beams please see p.74)

W (mm)	Code	Load UDL per rail (kg)
1229mm	TS/CGAR12/OR	100
1534mm	TS/CGAR15/OR	90
1839mm	TS/CGAR18/OR	80

① Includes garment rail, brackets and fixings, available in 624mm deep only (Frames Extra)

Garment Hanging Rail (For frames please see p.74)

W (mm)	Code	Load UDL per rail (kg)
1229mm	TS/GAR12/OR	100
1534mm	TS/GAR15/OR	90
1839mm	TS/GAR18/OR	80

① Includes 2x garment rails and safety pins. (Frames Extra)





CANTILEVER RACK

Our cantilever system is based on modular bays and fittings to provide cost effective storage of long and awkward items.

The frames are available in three heights and three depths in both single and double sided configurations. Each bay comes complete with three arms per frame and you can add or deduct the number of levels required.

The arms can be fitted with end stops (at an additional cost shown) to secure any loose products from falling off. The frames are spaced 1000mm or 1500mm apart with bolted on X brace, so you can easily work out your run using the starter and extension bay.

- **Incredible value for money**
- **Easy to build and reconfigure**
- **Up to 2200kgs per side**
- **Arms adjust every 75mm**
- **Tough epoxy finish**

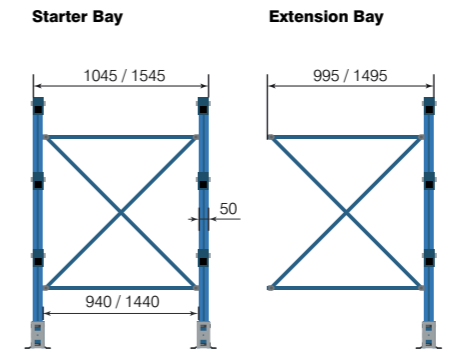
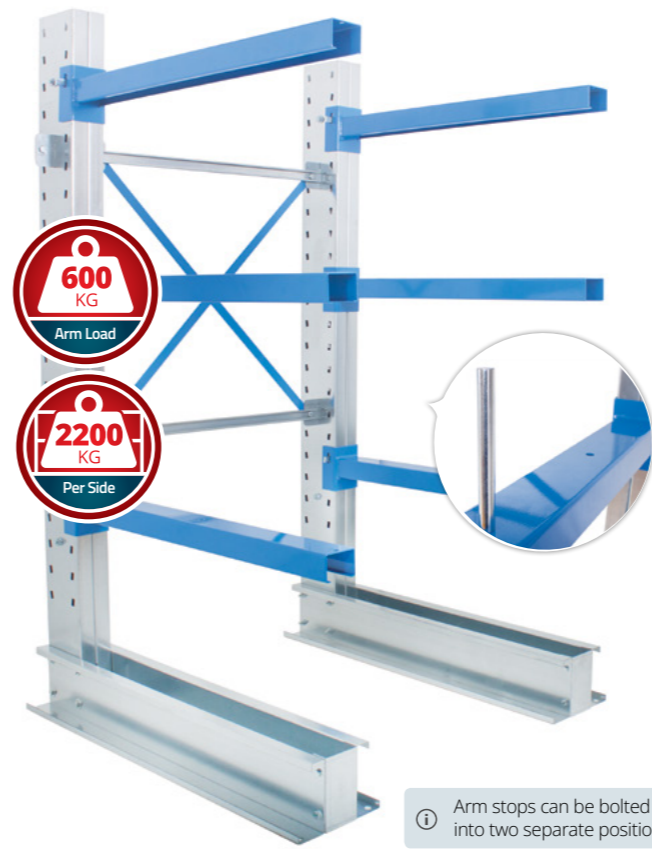

Available Depths (mm)

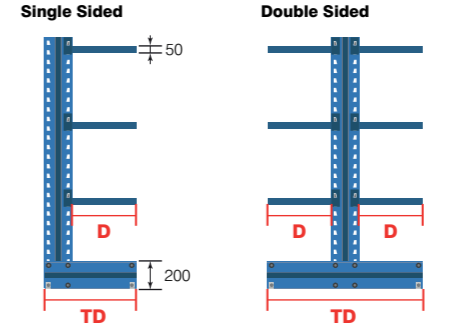

D	600	800
TD	800	1000

D Nominal Depth (as used in pricelists) **TD** Total Depth



Double Sided Cantilever Rack 1976 x 1500 x 600 +detail on arm attached to the column

Single Sided Cantilever Rack 1976 x 1000 x 1000 + Arm End Stop Detail

Single Sided 1000mm Wide		+Add Extension Bay	+Add Extra Arm	
Height x Depth	Starter Code	Extension Code	Extra Arm Code	Arm Capacity
1976 x 600mm	CMS/191006/S3	CME/191006/S3	CMAR/06	600kgs
1976 x 800mm	CMS/191008/S3	CME/191008/S3	CMAR/08	400kgs
1976 x 1000mm	CMS/191010/S3	CME/191010/S3	CMAR/10	250kgs
+For Taller Bays Add Prices				
H (mm)	Starter Code	Extension Code		
2432mm	CMS/24.../S3	CME/24.../S3		
2964mm	CMS/29.../S3	CME/29.../S3		
+For Arm End Stop				
Code				
CMAR/150ES				

Double Sided 1000mm Wide		+Add Extra Arm	
Starter Code	Extension Code	Extra Arm Code	Arm Capacity
CMS/191006/D3	CME/191006/D3	CMAR/06	600kgs
CMS/191008/D3	CME/191008/D3	CMAR/08	400kgs
CMS/191010/D3	CME/191010/D3	CMAR/10	250kgs
+For Taller Bays Add Prices			
CMS/24.../D3	CME/24.../D3		
CMS/29.../D3	CME/29.../D3		

All bays are supplied with a base and column per frame plus bracing and all necessary fixings (Floor Fixings ① 'M12x100' available on request). Single frames include three arms, double frames include six arms. Arm end stops are not included as standard, but can be ordered.

Heights	Widths	Depths	Construction	Loadings																
Standard height (mm) 1976	Widths (mm) 1000, 1500	Base depths (mm) Single sided 780, 980, 1180 Double sided 1380, 1780, 2180	Frame: Steel Galvanised	Max Load/Arm* 600kg																
Other available heights (mm) 2432, 2964		Arm Length 600, 800, 1000	Bracing: Steel Galvanised, Blue RAL5015	Max Load Per Side																
			Arms: Steel Blue RAL5015	<table border="1"> <tr> <th>Height (mm)</th> <th>Arm 600mm</th> <th>Arm 800mm</th> <th>Arm 1000mm</th> </tr> <tr> <td>1976mm</td> <td>2200kg</td> <td>1900kg</td> <td>1600kg</td> </tr> <tr> <td>2432mm</td> <td>2200kg</td> <td>1900kg</td> <td>1600kg</td> </tr> <tr> <td>2964mm</td> <td>2200kg</td> <td>1900kg</td> <td>1100kg</td> </tr> </table>	Height (mm)	Arm 600mm	Arm 800mm	Arm 1000mm	1976mm	2200kg	1900kg	1600kg	2432mm	2200kg	1900kg	1600kg	2964mm	2200kg	1900kg	1100kg
Height (mm)	Arm 600mm	Arm 800mm	Arm 1000mm																	
1976mm	2200kg	1900kg	1600kg																	
2432mm	2200kg	1900kg	1600kg																	
2964mm	2200kg	1900kg	1100kg																	
			Arm pins: Steel																	





VERTICAL RACK

A cost effective way of storing all those long and awkward items.

Our vertical racking is derived from our Heavy Duty Midspan system. The system comes as a starter and extension bay format meaning long runs are more cost effective.

The bays come with 3 dividers, all necessary frames and base plates, two front beams and one back beam and base rail. Other size racks available to order, please contact the sales office.

- Great value for money
- Store all your long awkward items
- Quickly gets your storage organized
- Simple to build and reconfigure
- Fully adjustable hoop dividers
- Starter and extension bay system
- Can be secured to the floor

Cost effective Vertical Storage for items up to 3000mm long!

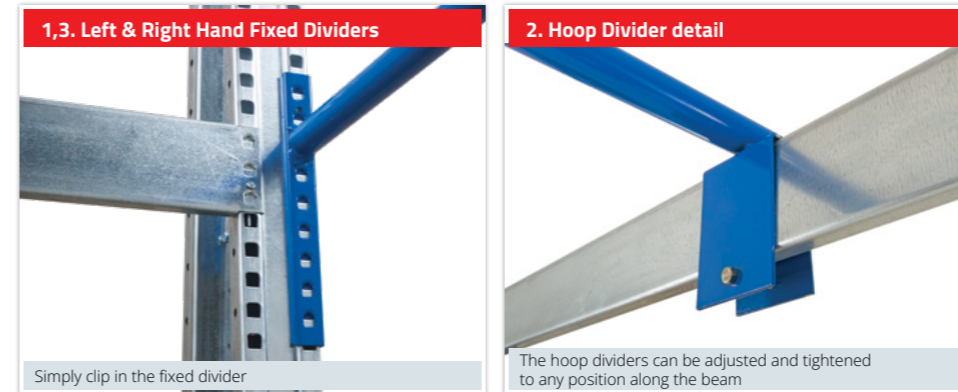

1,3. Left & Right Hand Fixed Dividers

2. Hoop Divider detail

Simply clip in the fixed divider

The hoop dividers can be adjusted and tightened to any position along the beam

Vertical Rack Available Widths (Height shown 2550mm)

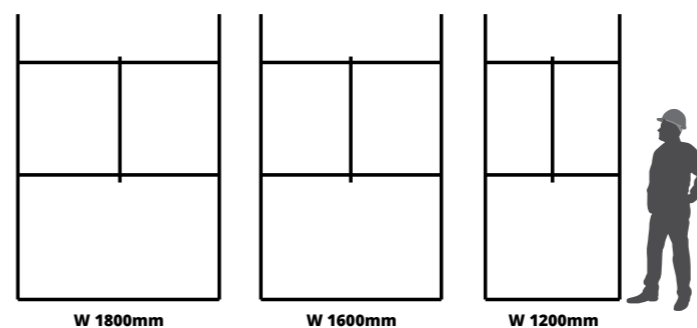

W 1800mm

W 1600mm

W 1200mm

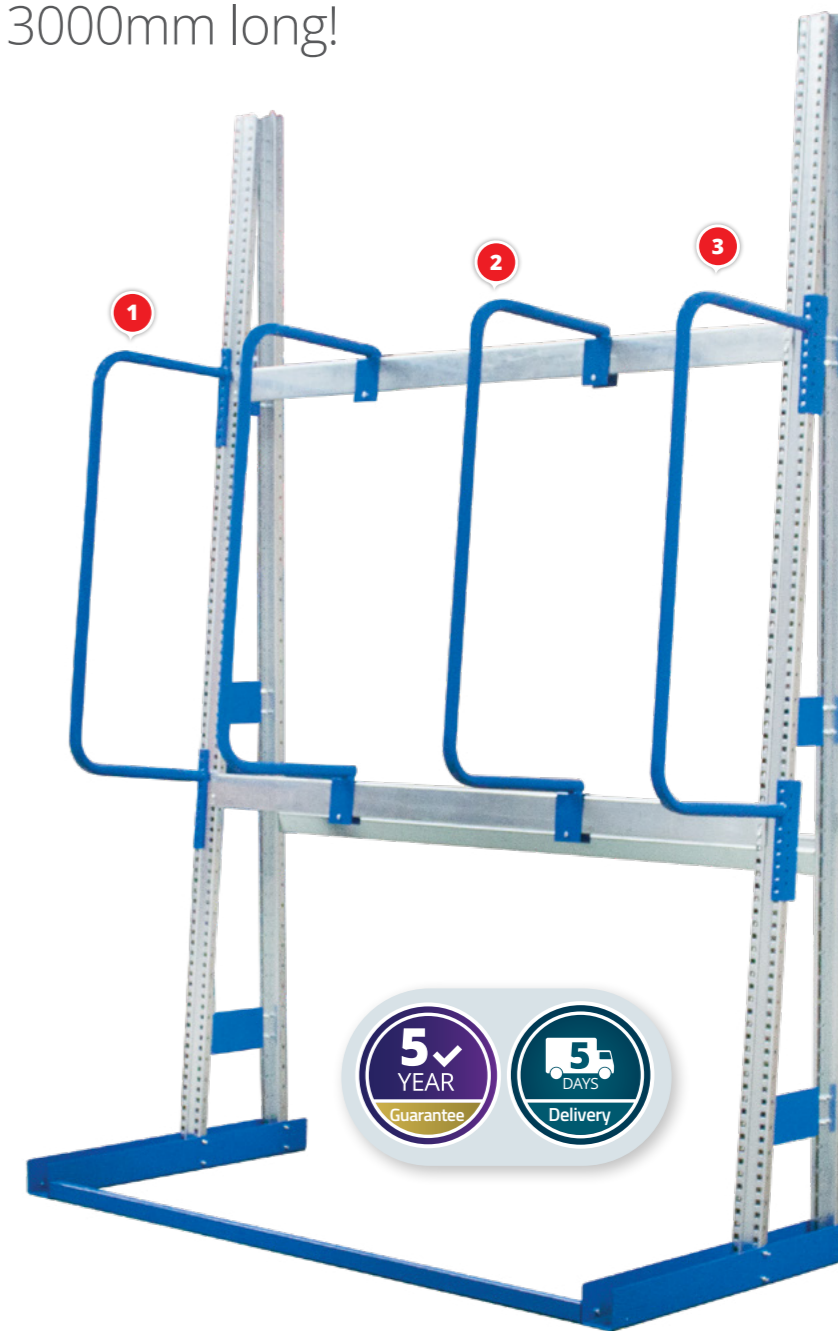

© Vertical Rack 2550 x 1600 x 810 with one extra hoop divider

	Vertical Rack	+Add Extension Bay
HxWxD (mm)	Starter Code	Extension Code
2550 x 1200 x 810	VRS/2512/3	VRE/2512/3
2550 x 1600 x 810	VRS/2516/3	VRE/2516/3
2550 x 1800 x 810	VRS/2518/3	VRE/2518/3

+For Adjustable Hoop Dividers

H x D (mm)	Code
1000 x 400mm	VR/DIV1.004

Starter Bay includes two side frames, beams, Right and Left hand dividers, one adjustable divider and all necessary fixings. Extension includes one side frame, beams, three adjustable dividers and all necessary fixings (Floor Fixings 'M12x100' available on request).



Heights

Frame height (mm)
2550

Store items up to
3000mm long!



Widths

Widths (mm)
1200, 1600, 1800



Depths

Frame depth (mm)
810

Divider Depth (mm)
400



Application

Environment
Stockroom, Workshop, Warehouse

Usage
Long Items Storage Vertically



Construction

Uprights: **Steel Galvanised**

Beams: **Steel Galvanised**

Dividers: **Steel Blue RAL5010**



Loadings

Contact Sales Office

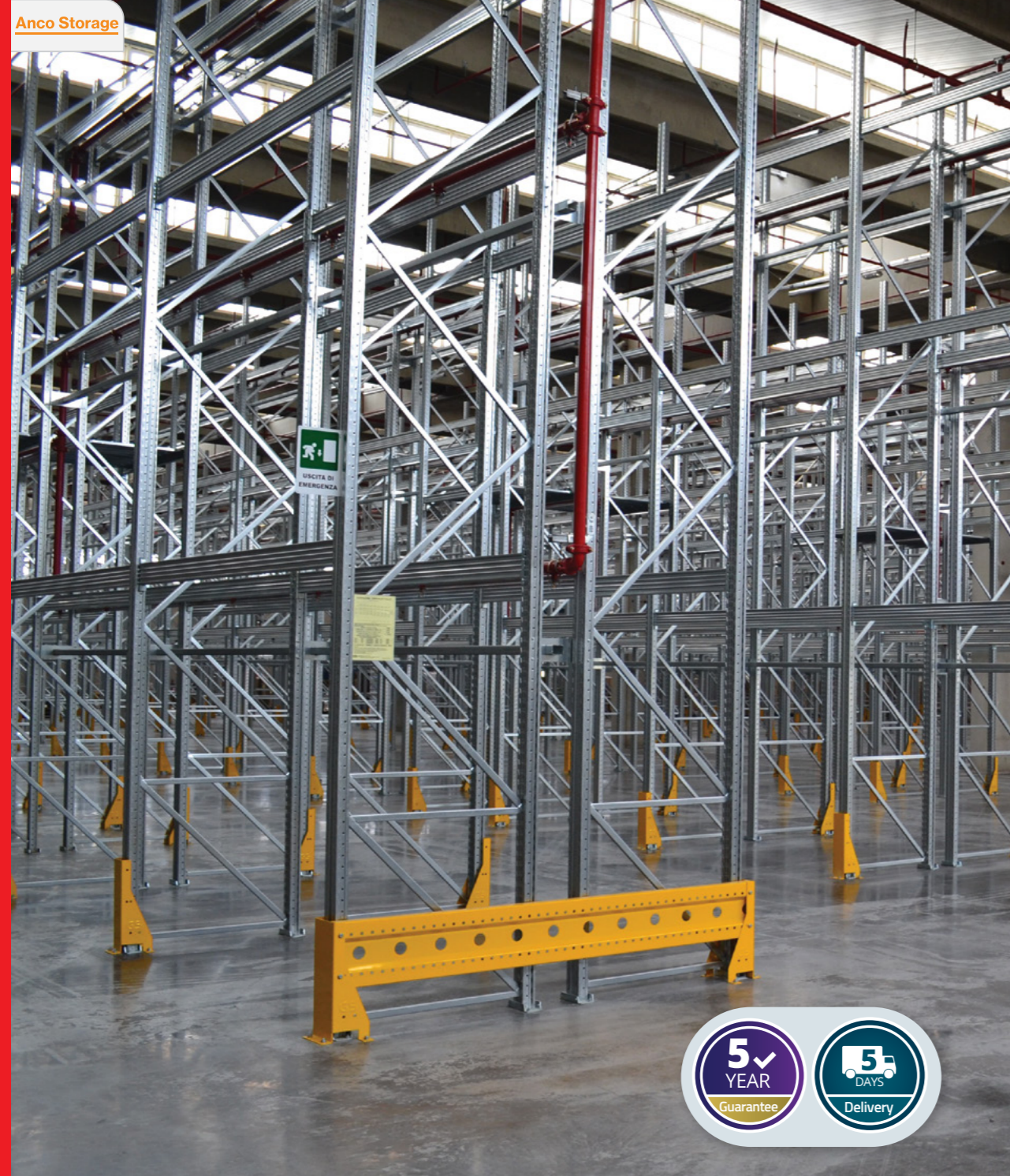

Anco Storage



PALLET RACKING

We have a variety of pallet racking options that will provide the perfect storage solution for your business.

We take full consideration that each business needs to find a storage solution which makes the most of the available space.

We will evaluate the type of goods you store, the amount of floor space available for the racking installation, the speed of throughput and the type of equipment you use before recommending the best solution.

- Adjustable pallet racking
- Push back pallet racking
- Pallet live racking
- External pallet racking
- Narrow aisle pallet racking
- Drive-In pallet racking

The fully flexible warehouse solution



Anco Storage



Heights

Height (mm)
2500, 3000,
4000, 5000, 6000



Widths

Widths (mm)
1350, 2225, 2700, 3300



Depths

Depths (mm)
900, 1100



Application

Environment
Warehouse

Usage
**Multipurpose Storage,
Heavy & Bulky Items,
Palletised Goods**



Construction

Frames: **Steel**
Galvanised

Beams: **Steel**
RAL 1003 Yellow

Please contact the Sales
Team for accessory
construction details



Loadings

Beam UDL (per pair)
Up to 3790kg

Choose your pallet and frame size

UK Pallet

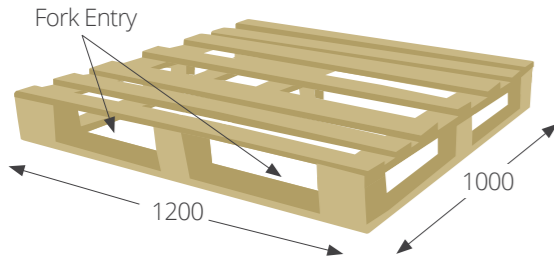

Frame

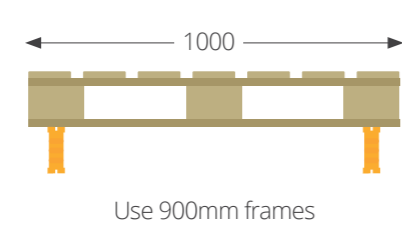

Euro Pallet

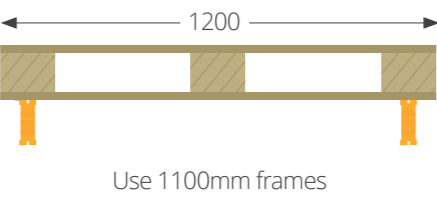
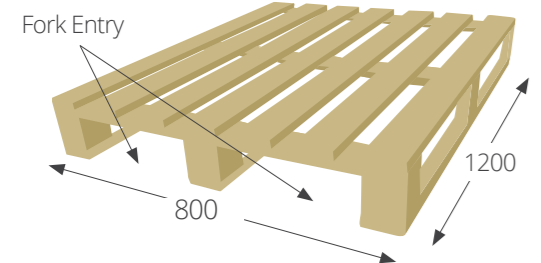

Design your layout

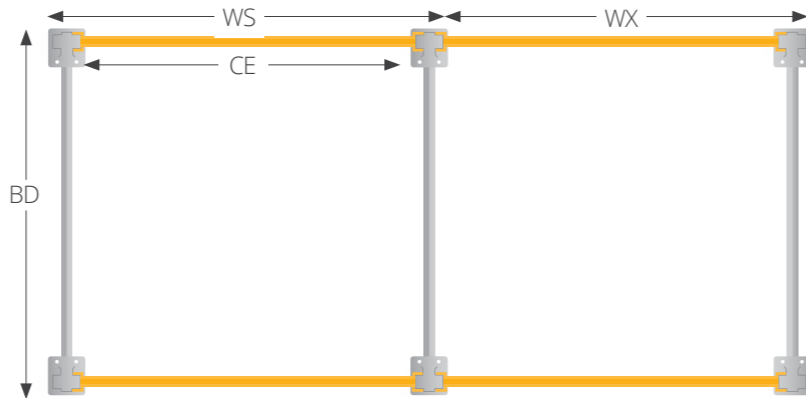

Nominal Depth (D)	BD Bay Depth	Nominal Width (W)	CE Clear Entry	WS Starter Bay	WX Extension Bay
900mm	920mm	1350mm	1313mm	1555mm	1456mm
1100mm	1120mm	2225mm	2183mm	2425mm	2326mm
		2700mm	2663mm	2905mm	2806mm
		3300mm	3263mm	3505mm	3406mm

Baseplate allowance for frame depth = 15mm, Baseplate allowance for entire row length = 31mm

Now available in frames up to 6000mm high



Frames

H (mm)	Depth	
	Depth - 900mm	Depth - 1100mm
2500mm	Code: MPRF/2509/GV	Code: MPRF/2511/GV
3000mm	Code: MPRF/3009/GV	Code: MPRF/3011/GV
4000mm	Code: MPRF/4009/GV	Code: MPRF/4011/GV
5000mm	Code: MPRF/5009/GV	Code: MPRF/5011/GV
6000mm	Code: MPRF/6009/GV	Code: MPRF/6011/GV

Beams

W (mm)	Code	Beam Profile (mm)	Load Per pair (kg)
1350	MPRB/1375/YW	75	3540
2225	MPRB/2210/YW	100	2800
2700	MPRB/2712/YW	125	3180
3300 (900mm Deep)	MPRB/331709/YW	175	3790
3300 (1100mm Deep)	MPRB/331711/YW	175	3790

Includes uprights, metal feet and all necessary bracing, and fixings (including throughbolts).
 *Frame capacity is calculated at a beam pitch of 1500mm, and a run of five 2700mm wide bays.



Accessories

Description	Code
Upright Protector Type L - 400mm	RPS/CCG4004
Upright Protector Type U - 400mm	RPS/UCG4004
200mm Row Spacer	MPRRS/20/GV
250mm Row Spacer	MPRRS/25/GV
Shim 1.0mm	MPR01/SHIM10
Floor Fixing M12 x 100	FFM12X100

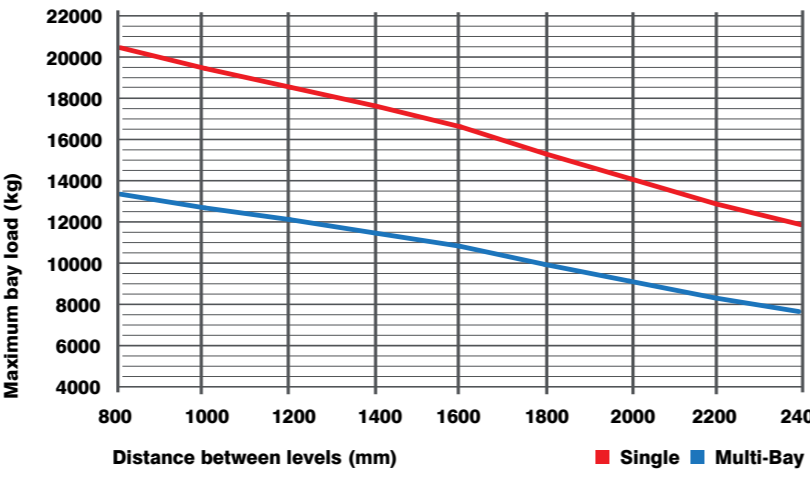
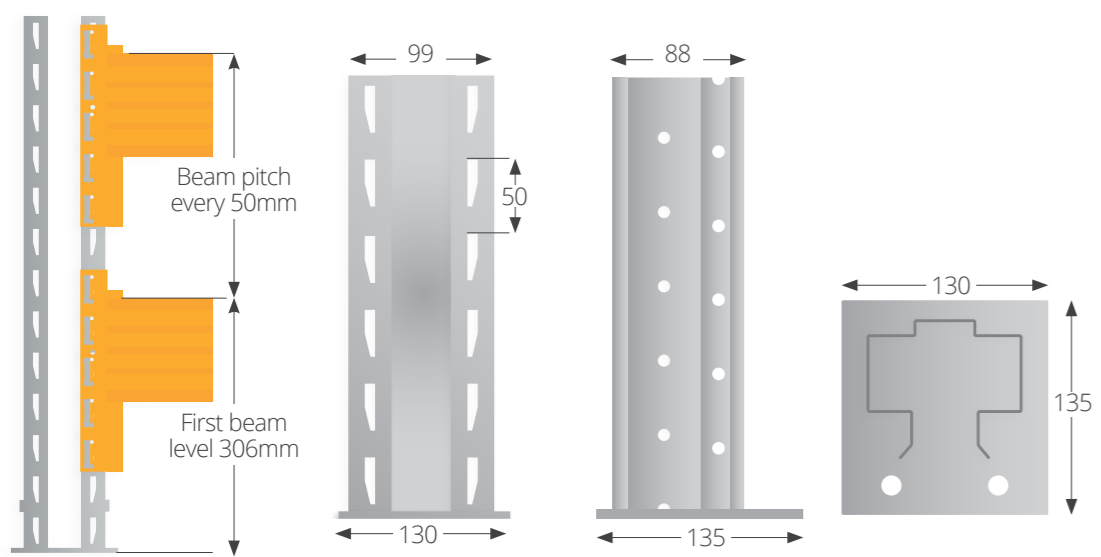

Frame capacity is calculated at a beam pitch of 1500mm, and a run of five 2700mm wide bays



Optimise your warehouse with Pallet Racking accessories

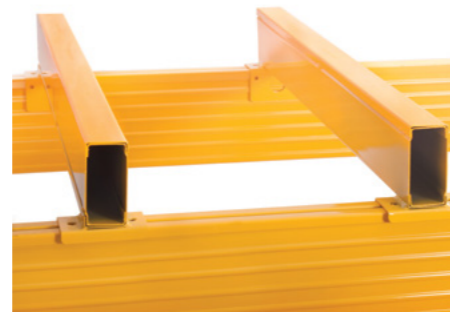

Fork Spacers		
D (mm)	Load (kgs)	Code
900 (Pair)	2000 (Pair)	MPRFS/09/YW
1100 (Pair)	2000 (Pair)	MPRFS/11/YW



Pallet Support Bars		
D (mm)	Load (kgs)	Code
900 (Pair)	1700 (Pair)	MPRSP/09/GV
1100 (Pair)	1500 (Pair)	MPRSP/11/GV

Open Timber Decking

W x D (mm)	Load (kgs)	Code
1350 x 900	500	MPROTD/1309
2225 x 900	810	MPROTD/2209
2700 x 900	1000	MPROTD/2709
3300 x 900	1226	MPROTD/3309
1350 x 1100	685	MPROTD/1311
2225 x 1100	1120	MPROTD/2211
2700 x 1100	1375	MPROTD/2711
3300 x 1100	1680	MPROTD/3311

Wire Decking Panels

W x D (mm)	Load (kgs)	Code
1350 x 900	1000	MPRMWD/1309
2700 x 900	2000	MPRMWD/2709
1350 x 1100	1000	MPRMWD/1311
2225 x 1100	2000	MPRMWD/2211
2700 x 1100	2000	MPRMWD/2711
3300 x 1100	3000	MPRMWD/3311

Standard pallet loads are 1000kgs for minimum 800mm deep pallets on 900mm deep pallet racking
Standard pallet loads are 1000kgs for minimum 1000mm deep pallets on 1100mm deep pallet racking



Choose your Pallet Racking Kit

900 Kits
For use with UK Pallets (1200 x 1000)

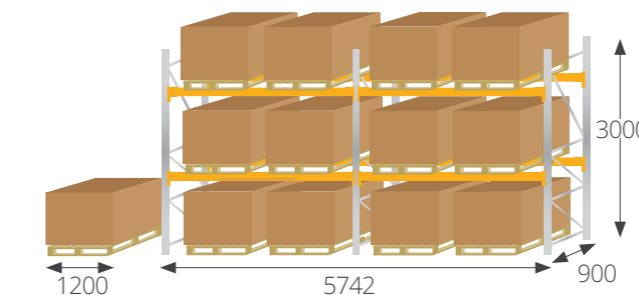

Pallet Racking Kit 1 for 12 x pallets (Boxes shown H: 1000 x W: 1200mm)

Pallet Racking Kit 1			
H x W x D (mm)	Code	Levels	Pallets Stored
3000 x 5742 x 900	MPRK1	2	12

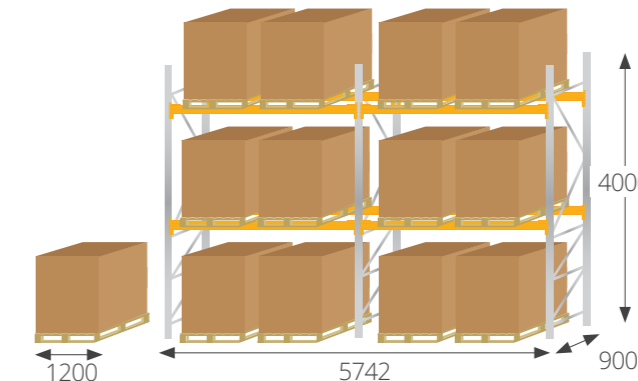

Pallet Racking Kit 2 for 12 x pallets (Boxes shown H: 1500 x W: 1200mm)

Pallet Racking Kit 2			
H x W x D (mm)	Code	Levels	Pallets Stored
4000 x 5742 x 900	MPRK2	2	12

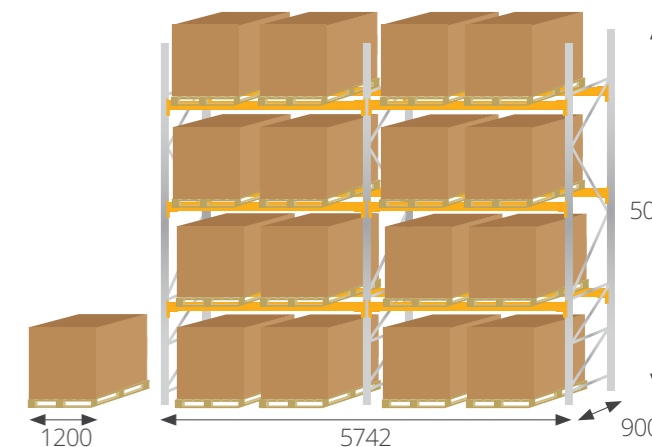

Pallet Racking Kit 3 for 16 x pallets (Boxes shown H: 1200 x W: 1200mm)

Pallet Racking Kit 3			
H x W x D (mm)	Code	Levels	Pallets Stored
5000 x 5742 x 900	MPRK3	3	16

1100 Kits
For use with Euro Pallets (800 x 1200)

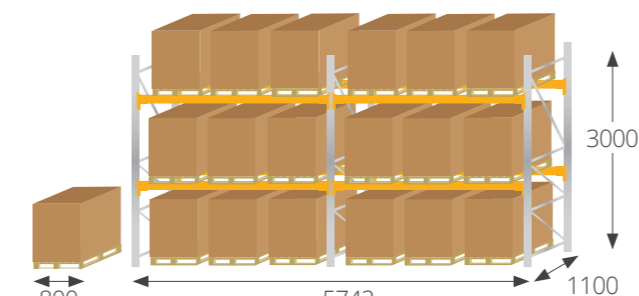

Pallet Racking Kit 4 for 18 x pallets (Boxes shown H: 1000 x W: 800mm)

Pallet Racking Kit 4			
H x W x D (mm)	Code	Levels	Pallets Stored
3000 x 5742 x 1100	MPRK4	2	18

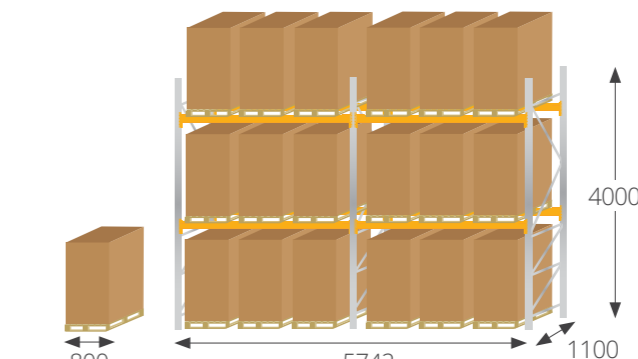

Pallet Racking Kit 5 for 18 x pallets (Boxes shown H: 1500 x W: 800mm)

Pallet Racking Kit 5			
H x W x D (mm)	Code	Levels	Pallets Stored
4000 x 5742 x 1100	MPRK5	2	18

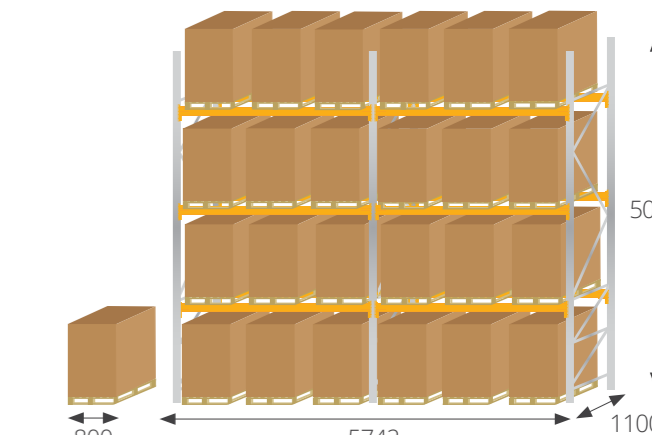

Pallet Racking Kit 6 for 24 x pallets (Boxes shown H: 1200 x W: 800mm)

Pallet Racking Kit 6			
H x W x D (mm)	Code	Levels	Pallets Stored
5000 x 5742 x 1100	MPRK6	3	24

Each kit includes one starter bay and one extension bay. The beams are 2700mm long. Loading capacity is 3790kgs per level. Each kit includes frames, beams, locking pins, levelling shims and floor fixings.





RACK ARMOUR®

The world-leading pallet racking protector.

Forklift and MHE impacts are a major cause of pallet racking damage. They can lead to expensive repairs, downtime, and serious safety risks.

Rack Armour is the ultimate pallet racking protection system that absorbs and deflects impact energy, safeguarding uprights where damage is most likely to occur.

Unlike traditional steel guards that transfer force into the rack and floor, which can rip out floor bolts or dent racking, Rack Armour clips directly onto the upright and deflects the force, reducing structural damage.

- **Manufactured from high-density polyethylene (HDPE) which deflects under impact**
- **Provides up to 80% reduction in damage levels**
- **Lifespan of 15+ years**
- **Energy absorbing design**
- **Quick and easy installation - no fixings required**
- **High visibility colours**



 Heights	 Widths	 Application	 Construction
Height (mm) 300 600 (Euro D and Euro E 600mm as standard) Bespoke sizes available on request	Front Facing Width (mm) Small (Euro A) - up to 87mm Medium (Euro B) - up to 100mm Large (Euro C) - up to 110mm XL (Euro D) - up to 120mm XXL (Euro E) - up to 135mm	Environment Warehouse Workshop Storeroom Chiller / Freezer	Plastic: HDPE and Foam Resistant to water, mould, corrosion, and most solvents

Choose your Rack Armour® size



① Please state colour when ordering:
/LY (Hi Vis Yellow) or /Y (Safety Yellow)

Description	Code	Upright Width	Height
Rack Armour® - Small (Euro A)	RAP70/300	Up to 87mm	300mm
Rack Armour® - Medium (Euro B)	RAP88/300	Up to 100mm	300mm
Rack Armour® - Large (Euro C)	RAP10/300	Up to 120mm	300mm
Rack Armour® - XL (Euro D)	RAP111/300	Up to 127mm	300mm
Rack Armour® - Small (Euro A)	RAP70	Up to 87mm	600mm
Rack Armour® - Medium (Euro B)	RAP88	Up to 100mm	600mm
Rack Armour® - Large (Euro C)	RAP10	Up to 120mm	600mm
Rack Armour® - XL (Euro D)	RAP111	Up to 127mm	600mm
Rack Armour® - XXL (Euro E)	RAP130	Up to 135mm	600mm

Unlike traditional steel guards that redirect impact force into the rack leg or concrete floor, Rack Armour® absorbs and dissipates energy before it can cause structural damage. Rack Armour® features a dual-layer construction:

- **Ultra-tough HDPE outer shell:** flexible, highly durable, resistant to cracking, denting, or corrosion
- **Reformable foam inner core:** engineered to absorb and dissipate impact energy

When struck, the outer shell flexes while the inner core compresses and absorbs the force. That means:

- Less damage to the racking
- Lower risk of upright dents or deformation
- Reduced need for rack repairs or replacement
- No damage to floor bolts



Description	Code
Installation Tool - Arms	RAIT/L
Installation Tool - Hook	RAIT/S

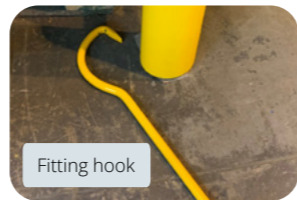

Corner Protector (Steel)



Size H x W x D	Code	Colour
400x200x200mm	RPS/CCG4004	Yellow (RAL1003)

Narrow Aisle Guard (Steel)



Size H x W x D	Code	Colour
400x160x280	RPS/UJCG4004	Yellow (RAL1003)

Rack Protection Barriers

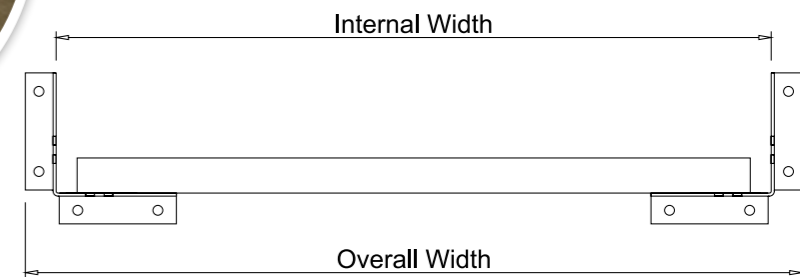

Size W x H	Overall Width	Internal Width	Colour	Code
1060x400mm	1060-1110mm	960-1010mm	Yellow/Galv	RPS/BRSET1060
1260x400mm	1260-1310mm	1160-1210mm	Yellow/Galv	RPS/BRSET1260
2230x400mm	2210-2260mm	2110-2160mm	Yellow/Galv	RPS/BRSET2230
2480x400mm	2460-2510mm	2360-2410mm	Yellow/Galv	RPS/BRSET2480
2560x400mm	2610-2660mm	2510-2560mm	Yellow/Galv	RPS/BRSET2560





HEAVY DUTY 'RHINO TUFF' PLASTIC BINS

With a lifetime guarantee, these plastic bins will perform in any environment time and time again.

Their strong robust design and shock proof plastic make these bins ideal for heavy duty industrial applications. The quality and ergonomic design means all our plastic bins can be stacked securely or hung on louvre panels or rails making them efficient in any small part picking environment.

They have a large identification area as well as a large open picking face, meaning the contents are easily identified and picked. With 10 sizes to choose from plus a range of wall panels, racks, trolleys and shelving bays.

- Small parts storage solution
- Made in tough shock proof plastic
- Lifetime guarantee
- Robust and ergonomic design
- Bins in 10 sizes, four colours
- Guaranteed delivery in 5 days



Our range of 'Rhino Tuff' Plastic Bins come with a Lifetime Guarantee



Bin Code	W x D x H (mm)	Load (kg)	Available Colours
ARTB05	106 x 106 x 49	1.5	Red, Yellow, Blue
ARTB10	106 x 136 x 76	2.5	Red, Yellow, Blue, Grey
ARTB20	106 x 187 x 76	3.5	Red, Yellow, Blue, Grey
ARTB25	140 x 205 x 127	6.5	Red, Yellow, Blue, Grey
ARTB30	140 x 274 x 127	10	Red, Yellow, Blue, Grey
ARTB35	210 x 279 x 179	15	Red, Yellow, Blue
ARTB40	210 x 375 x 179	20	Red, Yellow, Blue, Grey
ARTB50	280 x 457 x 254	25	Red, Yellow, Blue, Grey
ARTB60	415 x 375 x 179	22	Blue
ARTB70	415 x 460 x 292	40	Blue

Application

Environment
Workshop, Storeroom

Usage
Manufacturing, Small Parts Picking, High Density Storage

Construction

Heavy Duty Bins: **Plastic**
Red, Yellow, Blue
(ARTB60 & 70 - Blue Only)

Recycled Bins: **Plastic**
Light Grey

Loadings

Various Loadings



Our range of Louvre Panels

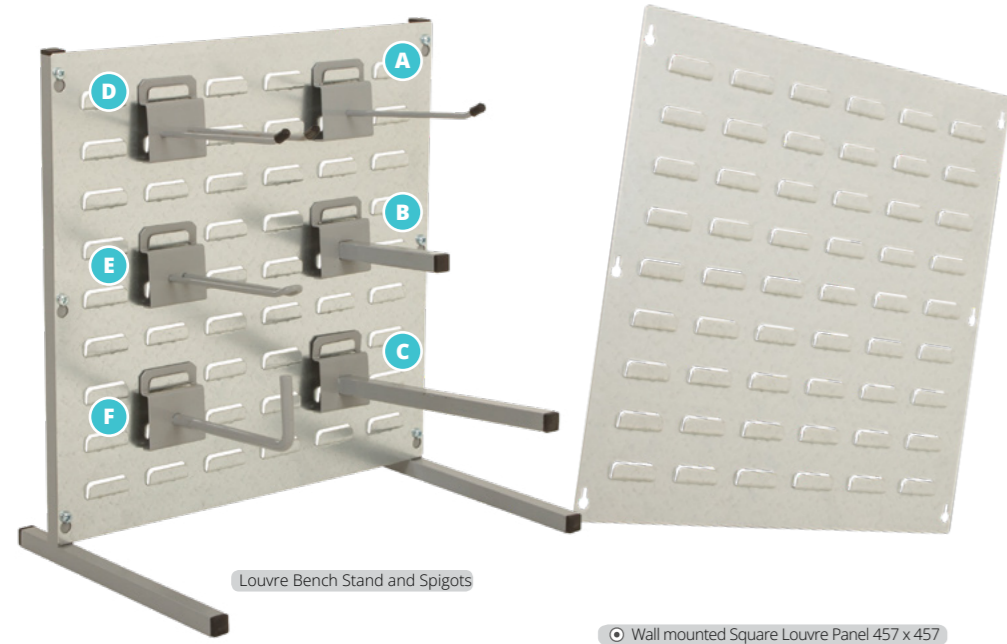

Louvre Bench Stand and Spigots

Wall mounted Square Louvre Panel 457 x 457

Louvre Panel				
Description	H x W (mm)	Code	Colour	LP Value (W x H)
☉ Square Louvre Panel	457 x 457	ARTBPLV0505	Galv	6 x 9
Portrait Louvre Panel	915 x 457	ARTBPLV1005P	Galv	6 x 19
Landscape Louvre Panel	457 x 915	ARTBPLV0510L	Galv	13 x 9
Bench Stand Louvre	457 x 457	ARTBBS0505	Galv	6 x 9

Spigots				
Description	Ref.	Code	Colour	LP Value (W x H)
Single Prong 200mm	A	ARTBSPSP200	Grey	1 x 2
Square Tube 150mm	B	ARTBSPST150	Grey	1 x 2
Square Tube 300mm	C	ARTBSPST300	Grey	1 x 2
Double Prong 200mm	D	ARTBSPDP200	Grey	1 x 2
Euro Hook 200mm	E	ARTBSPEK200	Grey	1 x 2
Steel Hook 200mm	F	ARTBSPHK200	Grey	1 x 2

Plastic Bin Features

- 1 Slot in dividers for bins ARTB30, 35, 40, 50, 60 and 70
- 2 Full length rear lip for louvre panels
- 3 Reinforced side walls to stop spreading
- 4 Extra wide and reinforced stacking base
- 5 Moulded finger grips for greater comfort
- 6 Large label area for better identification
- 7 Stop to prevent stacked bins slipping



Lifetime Guaranteed range of 'Rhino Tuff' Plastic Bins



Plastic Bins				
W x D x H (mm)	Code	Colour	LP Value (W x H)	Box Qty
106 x 106 x 49	ARTB05	Red, Blue, Yellow	1.5 x 2	24
106 x 136 x 76	ARTB10	Red, Blue, Yellow	1.5 x 2	24
106 x 187 x 76	ARTB20	Red, Blue, Yellow	1.5 x 2	24
140 x 205 x 127	ARTB25	Red, Blue, Yellow	2 x 3	20
140 x 274 x 127	ARTB30	Red, Blue, Yellow	2 x 3	20
210 x 279 x 179	ARTB35	Red, Blue, Yellow	3 x 4	20
210 x 375 x 179	ARTB40	Red, Blue, Yellow	3 x 4	10
280 x 457 x 254	ARTB50	Red, Blue, Yellow	4 x 6	6
415 x 375 x 179	ARTB60	Blue	6 x 4	5
415 x 460 x 292	ARTB70	Blue	6 x 6	3

☐ Supplied with label

Dividers		
D x H (mm)	Code	Colour
127 x 274	ARTBDIV3	Black
179 x 279	ARTBDIV35	Black
375 x 179	ARTBDIV4	Black
457 x 254	ARTBDIV5	Black
370 x 179	ARTBDIV6	Black
460 x 292	ARTBDIV7	Black

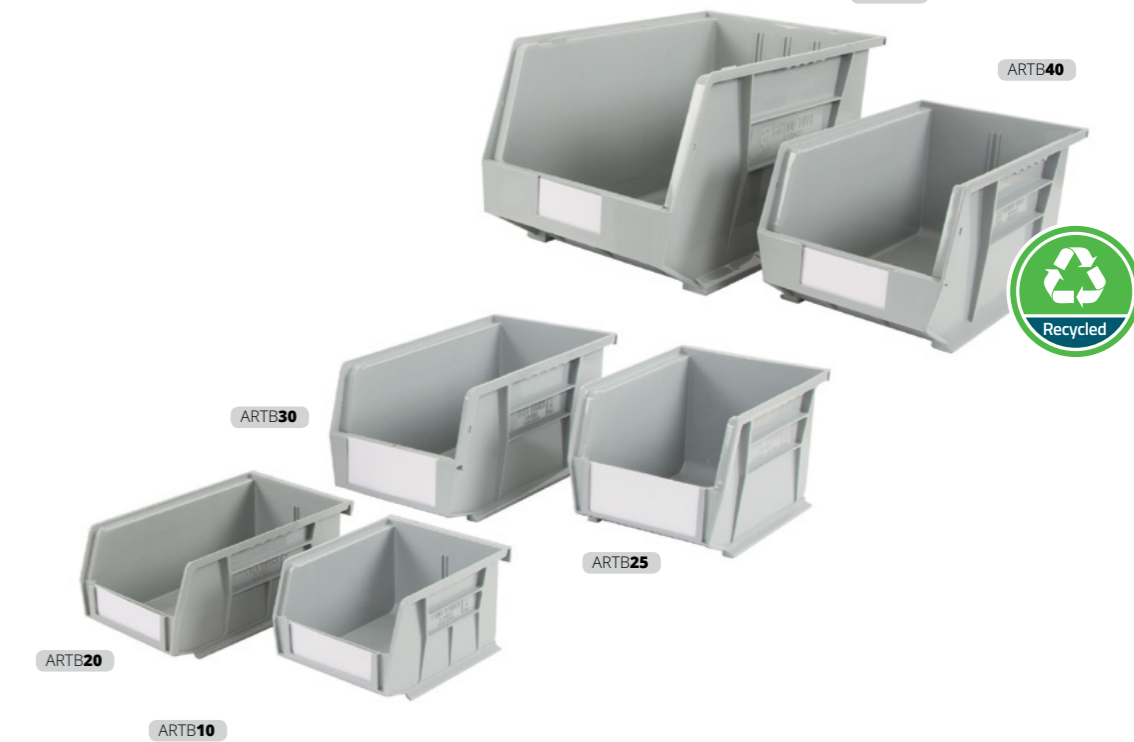

Plastic Bins on Wall Louvre Panels (457 x 457mm) and Bench Stands



Wall Kit N	
H x W (mm)	Code
457 x 457	ARTBKITWN
① Includes 457 x 457mm louvre panel with 4 x ARTB10, 8 x ARTB20, 3 x ARTB30 bins	



Wall Kit P	
H x W (mm)	Code
457 x 457	ARTBKITWP
① Includes 457 x 457mm louvre panel with 4 x ARTB10, 3 x ARTB25, 3 x ARTB30 bins	



Wall Kit Q	
H x W (mm)	Code
457 x 457	ARTBKITWQ
① Includes 457 x 457mm louvre panel with 9 x ARTB30 bins	



Wall Kit T	
H x W (mm)	Code
457 x 457	ARTBKITWT
① Includes 457 x 457mm louvre panel with 16 x ARTB20 bins	

Plastic Bins on landscape Wall Louvre Panels (457 x 915mm)



Wall Kit AL	
H x W (mm)	Code
457 x 915	ARTBKITWAL
① Includes 457 x 915mm louvre panel with 18 x ARTB30 bins	



Wall Kit BL	
H x W (mm)	Code
457 x 915	ARTBKITWBL
① Includes 457 x 915mm louvre panel with 8 x ARTB10, 8 x ARTB20, 6 x ARTB25, 6 x ARTB30 bins	



Wall Kit CL	
H x W (mm)	Code
457 x 915	ARTBKITWCL
① Includes 457 x 915mm louvre panel with 8 x ARTB20, 6 x ARTB30, 4 x ARTB40 bins	



Bench Stand Kit N	
H x W (mm)	Code
457 x 457	ARTBKITBN
① Includes 457 x 457mm louvre panel with 4 x ARTB10, 8 x ARTB20, 3 x ARTB30 bins	



Bench Stand Kit P	
H x W (mm)	Code
457 x 457	ARTBKITBP
① Includes 457 x 457mm louvre panel with 4 x ARTB10, 3 x ARTB25, 3 x ARTB30 bins	



Bench Stand Kit Q	
H x W (mm)	Code
457 x 457	ARTBKITBQ
① Includes 457 x 457mm louvre panel with 9 x ARTB30 bins	



Bench Stand Kit T	
H x W (mm)	Code
457 x 457	ARTBKITBT
① Includes 457 x 457mm louvre panel with 16 x ARTB20 bins	

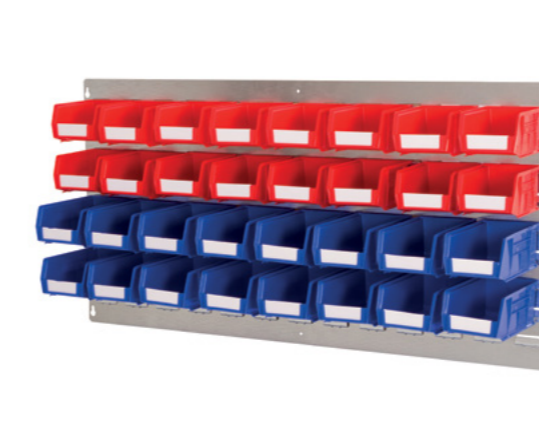

Wall Kit DL	
H x W (mm)	Code
457 x 915	ARTBKITWDL
① Includes 457 x 915mm louvre panel with 16 x ARTB10, 16 x ARTB20 bins	



Wall Kit EL	
H x W (mm)	Code
457 x 915	ARTBKITWEL
① Includes 457 x 915mm louvre panel with 8 x ARTB05, 8 x ARTB10, 8 x ARTB20, 6 x ARTB25 bins	



Wall Kit FL	
H x W (mm)	Code
457 x 915	ARTBKITWFL
① Includes 457 x 915mm louvre panel with 6 x ARTB25, 6 x ARTB30, 4 x ARTB40 bins	



Plastic Bins on portrait Wall Louvre Panels (915 x 457mm)

Keep small parts organised with our Plastic Bins Louvre Kits



Wall Kit AP	
H x W (mm)	Code
915 x 457	ARTBKITWAP
ⓘ Includes 915 x 457mm louvre panel with 6 x ARTB30, 6 x ARTB40	

Wall Kit BP	
H x W (mm)	Code
915 x 457	ARTBKITWBP
ⓘ Includes 915 x 457mm louvre panel with 8 x ARTB10, 12 x ARTB20, 9 x ARTB30	

Wall Kit CP	
H x W (mm)	Code
915 x 457	ARTBKITWCP
ⓘ Includes 915 x 457mm louvre panel with 18 x ARTB30	

Wall Kit DP	
H x W (mm)	Code
915 x 457	ARTBKITWDP
ⓘ Includes 915 x 457mm louvre panel with 36 x ARTB20	

Wall Kit JP	
H x W (mm)	Code
915 x 457	ARTBKITWJP
ⓘ Includes 915 x 457mm louvre panel with 36 x ARTB05	

Wall Kit KP	
H x W (mm)	Code
915 x 457	ARTBKITWKP
ⓘ Includes 915 x 457mm louvre panel with 36 x ARTB10	

Wall Kit LP	
H x W (mm)	Code
915 x 457	ARTBKITWLP
ⓘ Includes 915 x 457mm louvre panel with 16 x ARTB10, 20 x ARTB20	

Wall Kit MP	
H x W (mm)	Code
915 x 457	ARTBKITWMP
ⓘ Includes 915 x 457mm louvre panel with 18 x ARTB25	



Wall Kit EP	
H x W (mm)	Code
915 x 457	ARTBKITWEP
ⓘ Includes 915 x 457mm louvre panel with 3 x ARTB25, 3 x ARTB30, 2 x ARTB40, 2 x ARTB60	

Wall Kit FP	
H x W (mm)	Code
915 x 457	ARTBKITWFP
ⓘ Includes 915 x 457mm louvre panel with 8 x ARTB10, 8 x ARTB20, 6 x ARTB25, 6 x ARTB30	

Wall Kit GP	
H x W (mm)	Code
915 x 457	ARTBKITWGP
ⓘ Includes 915 x 457mm louvre panel with 5 x ARTB60	

Wall Kit HP	
H x W (mm)	Code
915 x 457	ARTBKITWHP
ⓘ Includes 915 x 457mm louvre panel with 10 x ARTB40	

Wall Kit NP	
H x W (mm)	Code
915 x 457	ARTBKITWNP
ⓘ Includes 915 x 457mm louvre panel with 9 x ARTB25, 9 x ARTB30	

Wall Kit PP	
H x W (mm)	Code
915 x 457	ARTBKITWPP
ⓘ Includes 915 x 457mm louvre panel with 4 x ARTB10, 4 x ARTB20, 3 x ARTB25, 3 x ARTB30, 2 x ARTB40, 1 x ARTB60	

Wall Kit QP	
H x W (mm)	Code
915 x 457	ARTBKITWQP
ⓘ Includes 915 x 457mm louvre panel with 4 x ARTB40, 2 x ARTB60	

Wall Kit RP	
H x W (mm)	Code
915 x 457	ARTBKITWRP
ⓘ Includes 915 x 457mm louvre panel with 3 x ARTB70	



Efficient way to organise high density small part picking walls



LOUVRE RACKS

Our range of louvre racks provide an efficient way to organise small parts bins which include every size for our Rhino range.

The racks provide a simple way to organise small part storage bins, providing a high density storage solution whilst maintaining an efficient way to retrieve items from the picking face.

The frames are made from strong box section profiles finished in light grey RAL 7035 and the louvre panels from hard wearing galvanized steel.



Louvre Rack dimensions (mm)

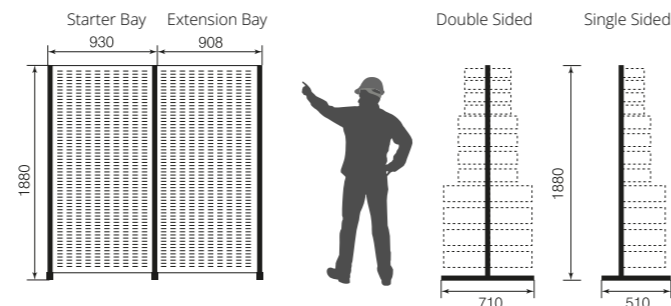

Louvre Racks (no bins)

Description	H x W (mm)	Code
Starter Rack - Single Sided	1920 x 930	ARTBRKSSS
Extension Rack - Single Sided	1920 x 930	ARTBRKSSE
Starter Rack - Double Sided	1920 x 930	ARTBRKDSS
Extension Rack - Double Sided	1920 x 930	ARTBRKDSE
<p>Includes frames with adjustable feet, 3 x louvre panels per side and all necessary fixings</p>		

High density storage solution with Louvre Racks and Plastic Bins



Single sided starter Louvre Rack with bins Kit A

Louvre Rack with Bins - Kit A		
Single Sided Racks	H x W (mm)	Code
Starter Rack (Single Sided - Kit A)	1920 x 930	ARTBRKSSSA
Extension Rack (Single Sided - Kit A)	1920 x 930	ARTBRKSSEA
<p>Includes single sided louvre rack with 16 x ARTB10, 24 x ARTB20, 12 x ARTB30, 8 x ARTB40, 6 x ARTB50 bins</p>		
Double Sided Racks	H x W (mm)	Code
Starter Rack (Double Sided - Kit A)	1920 x 930	ARTBRKDSSA
Extension Rack (Double Sided - Kit A)	1920 x 930	ARTBRKDSEA
<p>Includes double sided louvre rack with 32 x ARTB10, 48 x ARTB20, 24 x ARTB30, 16 x ARTB40, 12 x ARTB50 bins</p>		



Single sided starter Louvre Rack with bins Kit B

Louvre Rack with Bins - Kit B		
Single Sided Racks	H x W (mm)	Code
Rack B (Single Sided Starter)	1920 x 930	ARTBRKSSSB
Rack B (Single Sided Extension)	1920 x 930	ARTBRKSSEB
<p>Includes single sided louvre rack with 32 x ARTB20, 24x ARTB30, 16 x ARTB40 bins</p>		
Double Sided Racks	H x W (mm)	Code
Rack B (Double Sided Starter)	1920 x 930	ARTBRKDSSB
Rack B (Double Sided Extension)	1920 x 930	ARTBRKDSEB
<p>Includes double sided louvre rack with 64 x ARTB20, 48 x ARTB30, 32 x ARTB40 bins</p>		



Single sided starter Louvre Rack with bins Kit C

Louvre Rack with Bins - Kit C		
Single Sided Racks	H x W (mm)	Code
Rack C (Single Sided Starter)	£557.15	ARTBRKSSSC
Rack C (Single Sided Extension)	£494.20	ARTBRKSSEC
<p>Includes single sided louvre rack with 24 x ARTB10, 24 x ARTB20, 24 x ARTB30, 12 x ARTB40 bins</p>		
Double Sided Racks	H x W (mm)	Code
Rack C (Double Sided Starter)	1920 x 930	ARTBRKDSSC
Rack C (Double Sided Extension)	1920 x 930	ARTBRKDSEC
<p>Includes double sided louvre rack with 48 x ARTB10, 48 x ARTB20, 48 x ARTB30, 24 x ARTB40 bins</p>		



Best mobile solution for small parts picking



Double sided louvre trolley

LOUVRE TROLLEYS

Save wasted time travelling to items stored in static shelving installations by putting all your small parts storage bins onto our Louvre Trolleys.

Each trolley has been designed to perform to the highest standards with a robust frame design and tough galvanised louvre panels. Each unit comes with an ergonomic plastic handle so the unit can be comfortably moved. The trolley is fitted with heavy duty swivel castors, that offer ease of movement. Two of the castors are braked, which means the trolley can be secured when not in use.



Louvre Trolley dimensions (mm)

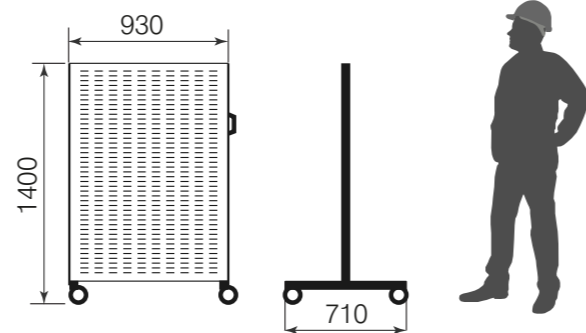

Louvre Trolley kits with Plastic Bins



Double sided louvre trolley



Double sided louvre trolley kit A



Double sided louvre trolley kit B

Double Sided Trolley (no bins)	
H x W (mm)	Code
1425 x 930	ARTBTY
Price includes complete trolley with 2 x braked + 2 x un-braked swivel castors, plastic handle and louvre panels on both sides	

Double Sided Trolley with Bins (A)	
H x W (mm)	Code
1425 x 930	ARTBTYA
Price includes complete trolley with 2x braked + 2 x un-braked swivel castors, plastic handle, louvre panels, 96 x ARTB20 and 48 x ARTB30 bins	

Double Sided Trolley with Bins (B)	
H x W (mm)	Code
1425 x 930	ARTBTYB
Price includes complete trolley with 2x braked + 2 x un-braked swivel castors, plastic handle, louvre panels, 32 x ARTB10, 48 x ARTB20, 24x ARTB30 and 16 x ARTB40 bins	





RIVET BAYS WITH PLASTIC BINS

A range of our J Rivet bays complete with our plastic storage bins.

The rivet bays have excellent strength and rigidity and offer full access on all four sides. There is a range of bays that have back to back bins offering picking from both faces of the single bay.



J Rivet Bay with Bins - Depth 305mm

H x W x D (mm)	Code
1830 x 915 x 305	ARTBJRRH01

① Includes J Rivet bay with 48 x ARTB30 bins



J Rivet Bay with Bins - Depth 457mm

H x W x D (mm)	Code
1830 x 915 x 457	ARTBJRRH02

① Includes J Rivet bay with 32 x ARTB40 bins



J Rivet Bay with Bins - Depth 457mm

H x W x D (mm)	Code
1830 x 915 x 457	ARTBJRRH03

① Includes J Rivet bay with 12 x ARTB50 bins



J Rivet Bay with Bins - Depth 610mm

H x W x D (mm)	Code
1830 x 915 x 610	ARTBJRRH04

① Includes J Rivet bay with 96 x ARTB30 bins

EXPO 4 BAYS WITH PLASTIC BINS

A range of EXPO 4 boltless shelving bays with our plastic storage bins.

All bays come complete with a open sides. Units are 2000mm high and are supplied with all plastic bins and labels. Please see the details below for bin quantities.



EXPO 4 Bay with Bins - Depth 400mm

H x W x D (mm)	Code
2000 x 1150 x 400	ARTBEXRH01

① Includes EXPO 4 bay with 9 shelves and 40 x ARTB40 bins



EXPO 4 Bay with Bins - Depth 400mm

H x W x D (mm)	Code
2000 x 1150 x 400	ARTBEXRH02

① Includes EXPO 4 bay with 10 shelves, 32 x ARTB30 and 25 x ARTB40 bins



EXPO 4 Bay with Bins - Depth 500mm

H x W x D (mm)	Code
2000 x 1000 x 500	ARTBEXRH03

① Includes EXPO 4 bay with 7 shelves and 18 x ARTB50 bins



EXPO 4 bay with Bins - Depth 300mm

H x W x D (mm)	Code
2000 x 1150 x 300	ARTBEXRH04

① Includes EXPO 4 bay with 11 shelves and 80 x ARTB30 bins



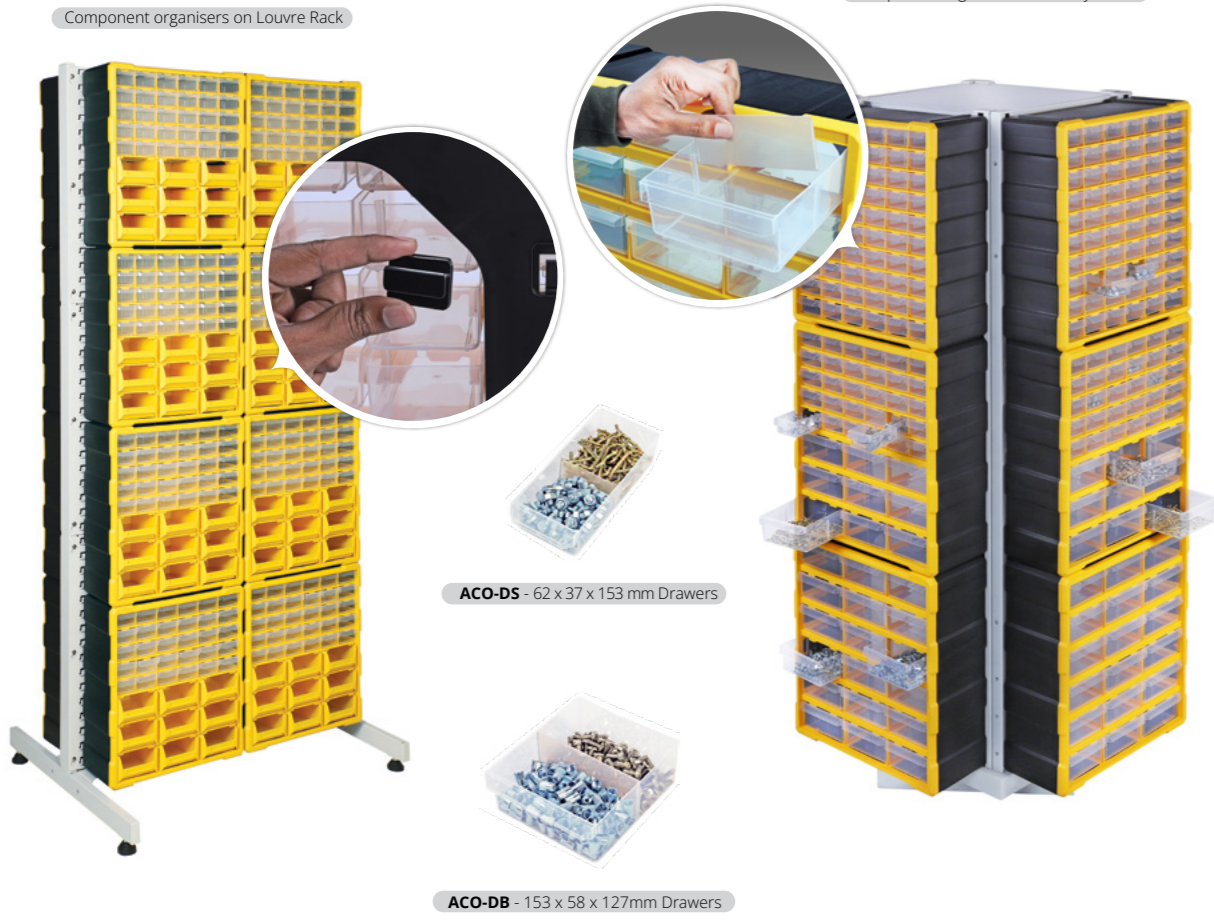

ACO-DS - 62 x 37 x 153 mm Drawers

ACO-DB - 153 x 58 x 127mm Drawers

COMPONENT ORGANISERS

Component Organisers are the perfect small parts organiser for your item storage needs. The Body and frame are made from durable High-Impact Polypropylene and the drawers and Partitions are made from transparent Polypropylene.

Each drawer comes with its own removable horizontal partition, effectively doubling the number of compartments which can be used in the component organiser.

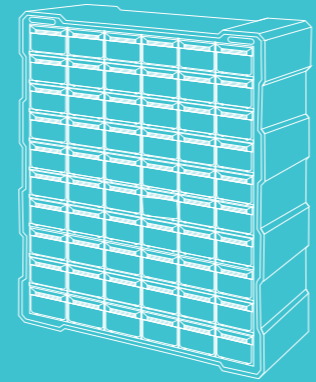

The component organisers can be screwed directly on a wall with the pre-configured holes on the rear side of the cabinet or mounted on a wall using specially designed frames.

The component organisers can be mounted on metal louvre panels with the help of four clips for better mounting which can be fitted on the back wall of the cabinet.

Chose your component organisers and build your own Kit



Component Organiser 12 Drawers	
W x H x D (mm)	Code
293 x 245 x 164	ACO12
Includes: 8 x ACO DB 153 x 58 x 127 mm Drawers & 4 x ACO DS 62 x 37 x 153 mm Drawers	



Component Organiser with 22 Drawers	
W x H x D (mm)	Code
555 x 245 x 164	ACO22
Includes: 8 x ACO DB 153 x 58 x 127 mm Drawers & 14 x ACO DS 62 x 37 x 153 mm Drawers	



Component Organiser with 9 Bins & 9 Drawers	
W x H x D (mm)	Code
424 x 457 x 164	ACO9B9D
Includes: 9 x ACO BIN 153 x 65 x 127 mm Bins & 9 x ACO DB 153 x 58 x 127 mm Drawers	



Component Organiser with 9 Bins & 30 Drawers	
W x H x D (mm)	Code
424 x 457 x 164	ACO9B30D
Includes: 9 x ACO BIN 153 x 65 x 127 mm Bins & 30 x ACO DS 62 x 37 x 153 mm Drawers	



Component Organiser with 18 Drawers	
W x H x D (mm)	Code
424 x 457 x 164	ACO18
Includes: 18 x ACO DB 153 x 58 x 127 mm Drawers	



Component Organiser with 39 Drawers	
W x H x D (mm)	Code
424 x 457 x 164	ACO39
Includes: 9 x ACO DB 153 x 58 x 127 mm Drawers & 30 x ACO DS 62 x 37 x 153 mm Drawers	



Component Organiser with 60 Drawers	
W x H x D (mm)	Code
424 x 457 x 164	ACO60
Includes: 30 x ACO DS 62 x 37 x 153 mm Drawers	



Component Organiser with 12 Pockets with Lids	
W x H x D (mm)	Code
426 x 460 x 166	ACO12PTL
Centre pocket dims: 123 x 125 x 68 mm Side pocket Dimensions 100 x 125 x 70 mm	

Heights	Widths	Depths	Application	Construction	Loadings
Height (mm) Multiple Options Available	Widths (mm) Multiple Options Available	Depths (mm) Multiple Options Available	Environment Storeroom, Workshop, Office, Garage, School, Warehouse, Hospitals, Pharmacies Usage Small Part Picking	Body & Frame: High Impact Polypropylene Transparent Parts: Polypropylene	N/A





Tilt Bin Application

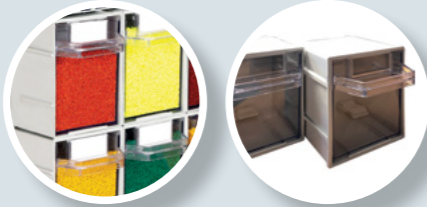

Tilt Bins can be **stacked** or **interlocked side-by-side**

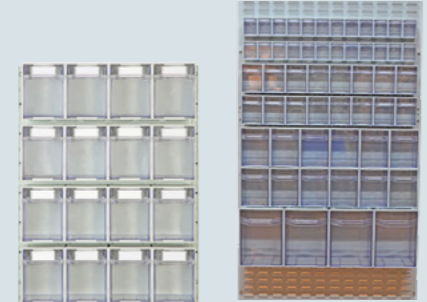

Secure Rhino Tilt Bins to a **wall** or fix them to a **louvre panel** or **trolley**



RHINO TILT BINS

Tilt Bins are designed with meticulous care for storage applications where products need to be stored, viewed and retrieved quickly, whilst remaining free from dirt and dust.

It has been designed as a two-component binning system formed of a cabinet and tilting bin, which pivots at the front bottom edge of the bin. Bins are available in four heights, widths and depths.

- Stack or interlock Tilt Bins side-by-side
- Use as a self-supporting structure, fix to a wall or Louvre panel using its specially designed adapter clip
- Large front handles with ergonomic grip
- Great for space saving and organising small parts



Rhino Tilt Bin with Cabinet Rhino Tilt Bin

Create your own Tilt Bin kits... Or choose from our pre-configured kits

1. Rhino Tilt Bin Size 1
RTB 1 LP Values (W x H) 1 x 2

2. Rhino Tilt Bin Size 2
RTB 2 LP Values (W x H) 1.5 x 3

3. Rhino Tilt Bin Size 3
RTB 3 LP Values (W x H) 2 x 4

4. Rhino Tilt Bin Size 4
RTB 4 LP Values (W x H) 3 x 6

Square Louvre Panels (457x457mm)



Total LP Value (W x H) 6 x 9



Portrait Louvre Panels (457x915mm)

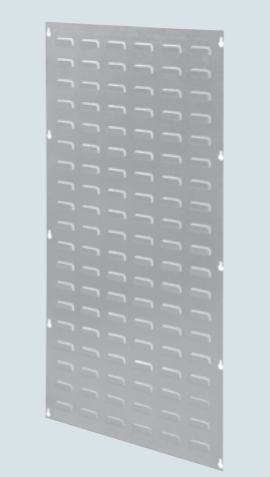

Total LP Value (W x H) 6 x 19

+ Louvre Panel			
Description	W x H (mm)	Code	LP Value (W x H)
Square Louvre Panel	457 x 457	ARTBPLV0505	6 x 9
Portrait Louvre Panel	457 X 915	ARTBPLV1005P	6 x 19
Landscape Louvre Panel	915 X 457	ARTBPLV0510L	13 x 6
Bench Stand Louvre	457 x 457	ARTBBS0505	6 x 9

+ Rhino Tilt Bins			
Description	W x D x H (mm)	Code	LP Value (W x H)
Rhino tilt bin size 1	73 x 50 x 92	RTB1	1 x 2
Rhino tilt bin size 2	108 x 90 x 141	RTB2	1.5 x 3
Rhino tilt bin size 3	144 x 121 x 193	RTB3	2 x 3
Rhino tilt bin size 4	215 x 167 x 283	RTB4	3 x 6
Rhino tilt bin spacer (For Bin 3)	68 x 120 x 190	RTB/SPR	-



Square Louvre Kit A	
W x H (mm)	Code
457 x 457	RTBKITA
Includes 457x457 Louvre Panel, 24x RTB1	



Square Louvre Kit B	
W x H (mm)	Code
457 x 457	RTBKITB
Includes 457x457 Louvre Panel, 12x RTB2	



Square Louvre Kit C	
W x H (mm)	Code
457 x 457	RTBKITC
Includes 457x457 Louvre Panel, 6x RTB3	



Square Louvre Kit D	
W x H (mm)	Code
457 x 457	RTBKITD
Includes 457x457 Louvre Panel, 2x RTB4	



Portrait Louvre Kit A	
W x H (mm)	Code
457 x 915	RTBKITAP
Includes 457x915 Louvre Panel, 48 x RTB1	



Portrait Louvre Kit B	
W x H (mm)	Code
457 x 915	RTBKITBP
Includes 457x915 Louvre Panel, 24 x RTB2	



Portrait Louvre Kit C	
W x H (mm)	Code
457 x 915	RTBKITCP
Includes 457x915 Louvre Panel, 12 x RTB3	



Portrait Louvre Kit D	
W x H (mm)	Code
457 x 915	RTBKITDP
Includes 457x915 Louvre Panel, 6 x RTB4	

Heights	Widths	Depths	Application	Construction	Loadings
Height (mm) 92, 141, 193, 283,	Widths (mm) 73, 108, 144, 215,	Depths (mm) 50, 90, 121, 167	Environment Hospitals, Storeroom, Workshop, Office, Warehouse Usage Small Part Picking	Cabinet: Plastic Grey RAL7035 Tilt Bin: High Impact Polystyrene Transparent	Contact sales office for details

Rhino Tilt Bin kits with Louvre Trolleys



Double-Sided Louvre Trolley Kit A	
W x H (mm)	Code
930 x 1425	RTBTYA
ⓘ Includes 930 x 1425 trolley, 24 RTB1, 32 RTB2, 12 RTB3, 16 RTB4	

Double-Sided Louvre Trolley Kit B	
W x H (mm)	Code
930 x 1425	RTBTYB
ⓘ Includes 930 x 1425 trolley, 48 RTB1, 32 RTB2, 24 RTB3, 8 RTB4	



Double-Sided Louvre Trolley Kit C	
W x H (mm)	Code
930 x 1425	RTBTYC
ⓘ Includes 930 x 1425 trolley, 64 RTB2, 36 RTB3	

Double-Sided Louvre Trolley Kit D	
W x H (mm)	Code
930 x 1425	RTBTYD
ⓘ Includes 930 x 1425 trolley, 72 RTB1, 48 RTB2, 24 RTB3	

Create your own kit

1
12 x RTB 1 LP Values (W x H)
12 x 2

2
8 x RTB 2 LP Values (W x H)
12 x 3

3
6 x RTB 3 LP Values (W x H)
12 x 4

4
4 x RTB 4 LP Values (W x H)
12 x 6

Double-Sided Louvre Trolleys



Total LP Value (W x H)
12 x 24 (Per Side)

Single-Sided Louvre Rack

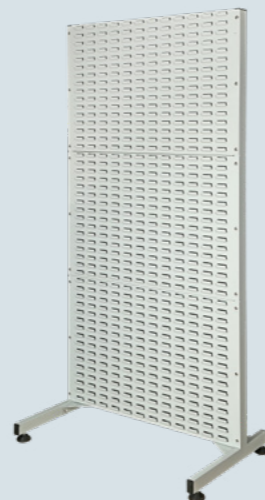

Total LP Value (W x H)
12 x 36

Double-Sided Louvre Rack

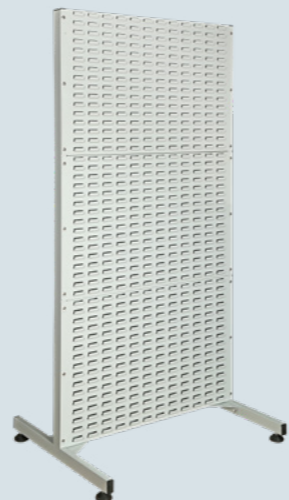

Total LP Value (W x H)
12 x 36 (Per Side)

Sizes

+ Double Sided Louvre Trolley			
Description	W x H (mm)	Price Code	LP Value (W x H)
Double Sided Trolley	930 x 1425	ARTBTY	12 x 24
+ Single Sided Louvre Rack			
Rack (Single Sided Starter)	930 x 1920	ARTBRKSSS	12 x 36
Rack (Single Sided Extension)	930 x 1920	ARTBRKSSSE	12 x 36
+ Double Sided Louvre Rack			
Rack (Double Sided Starter)	930 x 1920	ARTBRKDSS	12 x 36
Rack (Double Sided Extension)	930 x 1920	ARTBRKDSE	12 x 36
+ Rhino Tilt Bins			
Rhino tilt bin size 1	73 x 50 x 92	RTB1	1 x 2
Rhino tilt bin size 2	108 x 90 x 141	RTB2	1.5 x 3
Rhino tilt bin size 3	144 x 121 x 193	RTB3	2 x 3
Rhino tilt bin size 4	215 x 167 x 283	RTB4	3 x 6
Rhino tilt bin spacer (For Bin 3)	68 x 120 x 190	RTB/SPR	-



Rhino Tilt Bin kits with Louvre Racks



Single-Sided Louvre Rack Kit A	
W x H (mm)	Code
930 x 1920	RTBSSSA
ⓘ Includes 930 x 1920 single sided rack, 192 RTB1	



Single-Sided Louvre Rack Kit B	
W x H (mm)	Code
930 x 1920	RTBSSSB
ⓘ Includes 930 x 1920 single sided rack, 96 RTB2	



Single-Sided Louvre Rack Kit C	
W x H (mm)	Code
930 x 1920	RTBSSSC
ⓘ Includes 930 x 1920 single sided rack, 48 RTB3	



Single-Sided Louvre Rack Kit D	
W x H (mm)	Code
930 x 1920	RTBSSSD
ⓘ Includes 930 x 1920 single sided rack, 24 RTB4	



Double-Sided Louvre Rack Kit A	
W x H (mm)	Code
930 x 1920	RTBDSSA
ⓘ Includes 930 x 1920 double sided rack, 72 RTB1, 48 RTB2, 36 RTB3, 8 RTB4	



Double-Sided Louvre Rack Kit B	
W x H (mm)	Code
930 x 1920	RTBDSSB
ⓘ Includes 930 x 1920 double sided rack, 48 RTB1, 48 RTB2, 24 RTB3, 16 RTB4	



Double-Sided Louvre Rack Kit C	
W x H (mm)	Code
930 x 1920	RTBDSSC
ⓘ Includes 930 x 1920 double sided rack, 48 RTB1, 48 RTB2, 12 RTB3, 24 RTB4	



Double-Sided Louvre Rack Kit D	
W x H (mm)	Code
930 x 1920	RTBDSSD
ⓘ Includes 930 x 1920 double sided rack, 24 RTB1, 32 RTB2, 12 RTB3, 32 RTB4	



TILT BIN FRAMES & STANDS

Tilt Bins are designed to be wall mounted using the special wall mounting frame kit or be mounted on a self supporting, single or double sided stand.

Tilt bins with retaining bars are ideal in any situation where the tilt bins need to be secured such as Vans & mobile work areas but can also be unsecured quickly for easy access.



How to affix Tilt Bins on Vertical Frames

1. Having removed the Tilt Bin, insert the screw corresponding to the screw holes in the Tilt Bin Cabinet.
2. Screw into the Fixing Plate on the back of the Tilt Bin Cabinet.
3. Interlock the cabinets by sliding front to back. Then insert the fixing plates into the vertical frame.
4. Once in place tighten the screws to affix the Tilt Bin cabinet to the vertical frame.

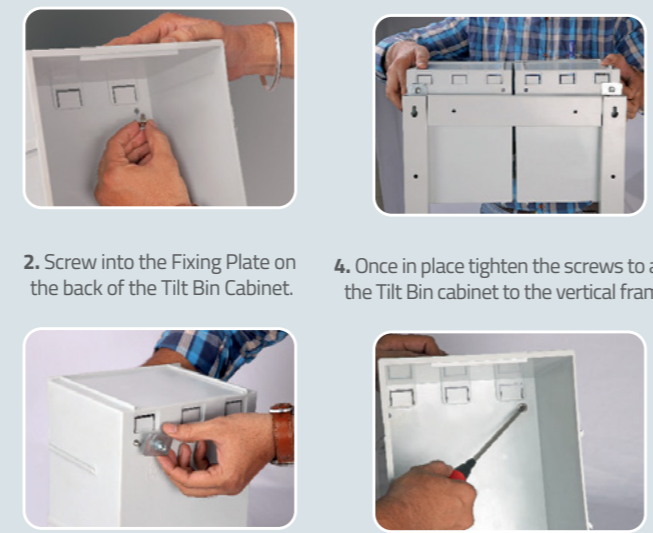

Tilt Bins with Retaining Bar ideal for Van Kits & Mobile Work Areas

Retaining bar



Code	Description	Qty & Bin Type
RTB1VK	Tilt Bin Kit 1 with Retaining Bar	6 x RTB1
RTB2VK	Tilt Bin Kit 2 with Retaining Bar	4 x RTB2
RTB3VK	Tilt Bin Kit 3 with Retaining Bar	3 x RTB3
RTB4VK	Tilt Bin Kit 4 with Retaining Bar	2 x RTB4

Configure your own kit by selecting your frame & bin type

Single Sided Stand	
W x H x D (mm)	Code
425x965x300	RTBSS/042/095
425x1260x300	RTBSS/042/125
425x1670x300	RTBSS/042/165
425x1950x300	RTBSS/042/195
ⓘ Does not include Bins	

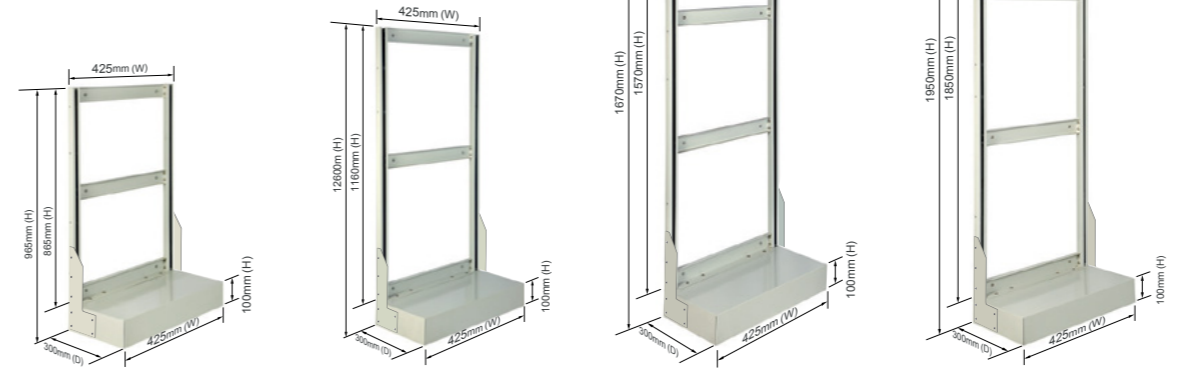

+ Rhino Tilt Bins		
Description	W x D x H (mm)	Code
Rhino Tilt Bin Size 1	73 x 50 x 92	RTB1
Rhino Tilt Bin Size 2	108 x 90 x 141	RTB2
Rhino Tilt Bin Size 3	144 x 121 x 193	RTB3
Rhino Tilt Bin Size 4	215 x 167 x 283	RTB4

Double Sided Stand	
W x H x D (mm)	Code
425x965x600	RTBDS/042/095
425x1260x600	RTBDS/042/125
425x1670x600	RTBDS/042/156
425x1950x600	RTBDS/042/195
ⓘ Does not include Bins	

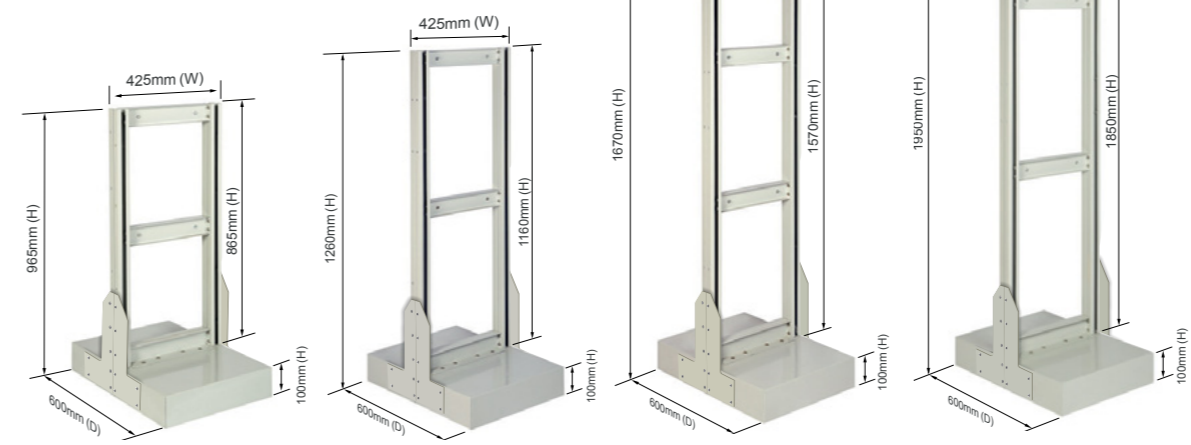

Wall Mounted Frame	
W x H x D (mm)	Code
425x865x27	RTBW/042/086
425x1160x27	RTBW/042/116
425x1570x27	RTBW/042/156
425x1850x27	RTBW/042/186
ⓘ Does not include Bins	

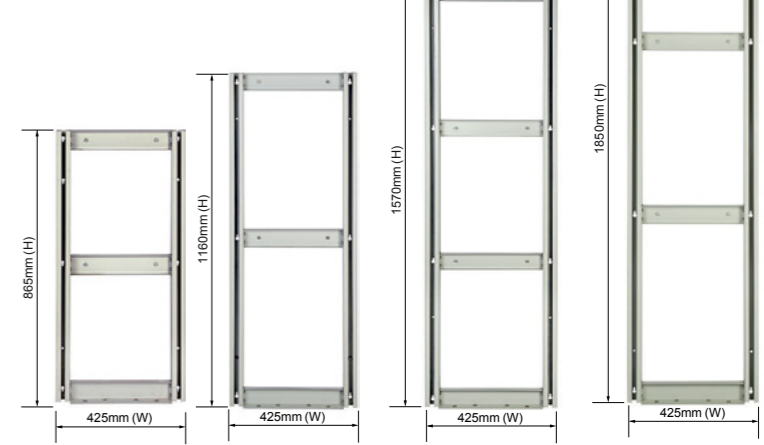



Type	W x H (mm)	Code
Wall Mounted	425x865	RTBW-01
Single Sided	425x965x300	RTBSS-01
Kits Include: 54 x RTB1		
Double Sided	425x965x600	RTBDS-01
Kits Include: 108 x RTB1		



Type	W x H (mm)	Code
Wall Mounted	425x865	RTBW-02
Single Sided	425x965x300	RTBSS-02
Kits Include: 24 x RTB2		
Double Sided	425x965x600	RTBDS-02
Kits Include: 48 x RTB2		



Type	W x H (mm)	Code
Wall Mounted	425x865	RTBW-03
Single Sided	425x965x300	RTBSS-03
Kits Include: 6 x RTB1, 12 x RTB3		
Double Sided	425x965x600	RTBDS-03
Kits Include: 12 x RTB1, 24 x RTB3		



Type	W x H (mm)	Code
Wall Mounted	425x865	RTBW-04
Single Sided	425x965x300	RTBSS-04
Kits Include: 6 x RTB4		
Double Sided	425x965x600	RTBDS-04
Kits Include: 12 x RTB4		



Type	W x H (mm)	Code
Wall Mounted	425x1160	RTBW-09
Single Sided	425x1260x300	RTBSS-09
Kits Include: 72 x RTB1		
Double Sided	425x1260x600	RTBDS-09
Kits Include: 144 x RTB1		



Type	W x H (mm)	Code
Wall Mounted	425x1160	RTBW-10
Single Sided	425x1260x300	RTBSS-10
Kits Include: 32 x RTB2		
Double Sided	425x1260x600	RTBDS-10
Kits Include: 64 x RTB2		



Type	W x H (mm)	Code
Wall Mounted	425x1160	RTBW-11
Single Sided	425x1260x300	RTBSS-11
Kits Include: 18 x RTB3		
Double Sided	425x1260x600	RTBDS-11
Kits Include: 36 x RTB3		



Type	W x H (mm)	Code
Wall Mounted	425x1160	RTBW-12
Single Sided	425x1260x300	RTBSS-12
Kits Include: 8 x RTB4		
Double Sided	425x1260x600	RTBDS-12
Kits Include: 16 x RTB4		



Type	W x H (mm)	Code
Wall Mounted	425x865	RTBW-05
Single Sided	425x965x300	RTBSS-05
Kits Include: 12 x RTB1, 8 x RTB2, 6 x RTB3		
Double Sided	425x965x600	RTBDS-05
Kits Include: 24 x RTB1, 16 x RTB2, 12 x RTB3		



Type	W x H (mm)	Code
Wall Mounted	425x865	RTBW-06
Single Sided	425x965x300	RTBSS-06
Kits Include: 6 x RTB1, 8 x RTB2, 3 x RTB3, 2 x RTB4		
Double Sided	425x965x600	RTBDS-06
Kits Include: 12 x RTB1, 16 x RTB2, 6 x RTB3, 4 x RTB4		



Type	W x H (mm)	Code
Wall Mounted	425x865	RTBW-07
Single Sided	425x965x300	RTBSS-07
Kits Include: 8 x RTB2, 4 x RTB4		
Double Sided	425x965x600	RTBDS-07
Kits Include: 16 x RTB2, 8 x RTB4		



Type	W x H (mm)	Code
Wall Mounted	425x865	RTBW-08
Single Sided	425x965x300	RTBSS-08
Kits Include: 18 x RTB1, 9 x RTB3		
Double Sided	425x965x600	RTBDS-08
Kits Include: 36 x RTB1, 18 x RTB3		



Type	W x H (mm)	Code
Wall Mounted	425x1160	RTBW-13
Single Sided	425x1260x300	RTBSS-13
Kits Include: 12 x RTB, 8 x RTB2, 6 x RTB3, 2 x RTB4		
Double Sided	425x1260x600	RTBDS-13
Kits Include: 24 x RTB1, 16 x RTB2, 12 x RTB3, 4x RTB4		



Type	W x H (mm)	Code
Wall Mounted	425x1160	RTBW-14
Single Sided	425x1260x300	RTBSS-14
Kits Include: 6 x RTB1, 8 x RTB2, 3 x RTB3, 4 x RTB4		
Double Sided	425x1260x600	RTBDS-14
Kits Include: 12 x RTB1, 16 x RTB2, 6 x RTB3, 8 x RTB4		



Type	W x H (mm)	Code
Wall Mounted	425x1160	RTBW-15
Single Sided	425x1260x300	RTBSS-15
Kits Include: 16 x RTB2, 9 x RTB3		
Double Sided	425x1260x600	RTBDS-15
Kits Include: 32 x RTB2, 18 x RTB3		



Type	W x H (mm)	Code
Wall Mounted	425x1160	RTBW-16
Single Sided	425x1260x300	RTBSS-16
Kits Include: 30 x RTB1, 8 x RTB2, 6 x RTB3		
Double Sided	425x1260x600	RTBDS-16
Kits Include: 60 x RTB1, 16 x RTB2, 12 x RTB3		

SHELF TRAYS

Our range of shelf trays are designed for strength and ease to use at a competitive price.

Our shelf trays feature a spring loaded shelf stop at the back of the tray. This means the tray can be withdrawn from the shelf and suspended offering around 90% clear picking. This stop also acts as a handle to make it easier to carry.

With shelf trays available in 3 depths, 2 widths and 2 heights any configuration can be designed to offer the maximum high density storage solution. Trays can be sub divided from left to right and all trays and dividers come with labels.

- Improved strength and rigidity
- More ergonomic features
- Sprung loaded shelf stop
- Can be sub divided
- High density storage system
- Offers fast retrieval times
- Large range of sizes
- Goods are kept clean
- Better product identification
- Uprights are Blue RAL5010
- Shelves are White RAL9010



High density small parts storage at its best using our range of Shelf Trays



Heights

Tray heights (mm)
90, 140

*Bay height (mm)
2000



Widths

Tray widths (mm)
117, 234

*Bay Width (mm)
1000



Depths

Tray depths (mm)
300, 400, 500

* Bay depths (mm)
300, 400, 500



Application

Environment
Warehouse, Storeroom, Workshop

Usage
Small parts storage and picking, High density storage



Construction

Trays: **Plastic**
Light Blue

Label Cover: **Plastic**
Clear Transparent

Internal Dividers: **Plastic**

Spring Handle: **Steel**

Front cover paper labels included



Loadings

*Max Bay Load
2500kg

*Shelf UDL
D300 **120kg**
D400 **120kg**
D500 **120kg**



BAY A | H 2000 x W 1000 (mm)

Depth (mm)	Starter Code	Extension Code
300mm	STA03S	STA03E
400mm	STA04S	STA04E
500mm	STA05S	STA05E

Includes (W x H) 16 x No. 117 x 90, 12 x No. 234 x 90, 12 x No. 234 x 140 trays*



BAY B | H 2000 x W 1000 (mm)

Depth (mm)	Starter Code	Extension Code
300mm	STB03S	STB03E
400mm	STB04S	STB04E
500mm	STB05S	STB05E

Includes (W x H) 64 x No. 117 x 90 trays*



BAY C | H 2000 x W 1000 (mm)

Depth (mm)	Starter Code	Extension Code
300mm	STC03S	STC03E
400mm	STC04S	STC04E
500mm	STC05S	STC05E

Includes (W x H) 32 x No. 234 x 90 trays*



BAY D | H 2000 x W 1000 (mm)

Depth (mm)	Starter Code	Extension Code
300mm	STD03S	STD03E
400mm	STD04S	STD04E
500mm	STD05S	STD05E

Includes (W x H) 28 x No. 234 x 140 trays*



BAY E | H 2000 x W 1000 (mm)

Depth (mm)	Starter Code	Extension Code
300mm	STE03S	STE03E
400mm	STE04S	STE04E
500mm	STE05S	STE05E

Includes (W x H) 32 x No. 117 x 90, 16 x No. 234 x 90, 20 x No. 234 x 140 trays*



BAY F | H 2000 x W 1000 (mm)

Depth (mm)	Starter Code	Extension Code
300mm	STF03S	STF03E
400mm	STF04S	STF04E
500mm	STF05S	STF05E

Includes (W x H) 120 x No. 117 x 90 trays*



BAY G | H 2000 x W 1000 (mm)

Depth (mm)	Starter Code	Extension Code
300mm	STG03S	STG03E
400mm	STG04S	STG04E
500mm	STG05S	STG05E

Includes (W x H) 60 x No. 234 x 90 trays*



BAY H | H 2000 x W 1000 (mm)

Depth (mm)	Starter Code	Extension Code
300mm	STH03S	STH03E
400mm	STH04S	STH04E
500mm	STH05S	STH05E

Includes (W x H) 44 x No. 234 x 140 trays*

Our range of Shelf Trays helps to quickly store, organise and identify small parts

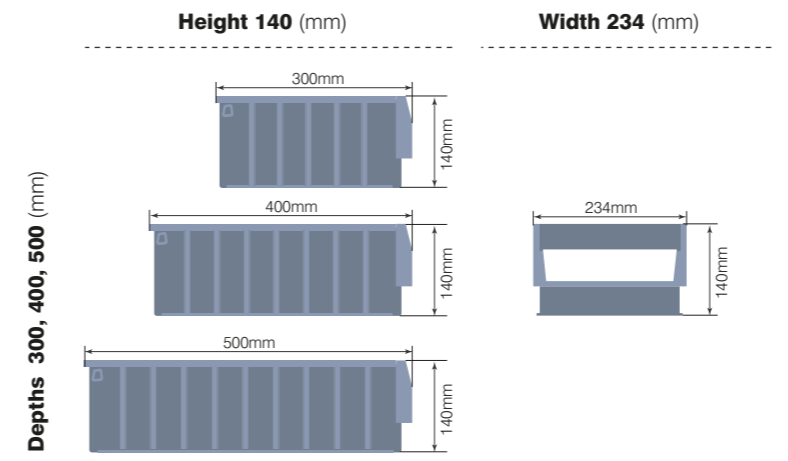
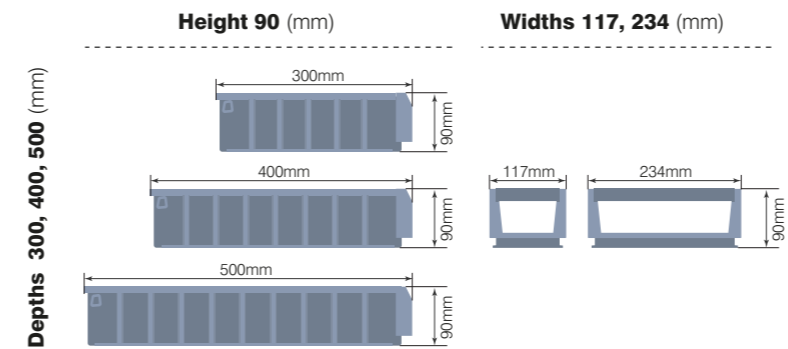

Shelf Tray 300 x 117 x 90 with 1. Front cover & paper label 2. Dividers with holder for label & 3. Spring handle

Shelf Trays			
	D x W x H (mm)	Code	Colour
D 300mm	300 x 117 x 90	ST3109	Light Blue
	300 x 234 x 90	ST3209	Light Blue
	300 x 234 x 140	ST3214	Light Blue
D 400mm	400 x 117 x 90	ST4109	Light Blue
	400 x 234 x 90	ST4209	Light Blue
	400 x 234 x 140	ST4214	Light Blue
D 500mm	500 x 117 x 90	ST5109	Light Blue
	500 x 234 x 90	ST5209	Light Blue
	500 x 234 x 140	ST5214	Light Blue

Each tray includes front cover & paper label

+Add Dividers		
W x H (mm)	Code	Colour
117 x 90	STDIV109	Translucent
234 x 90	STDIV209	Translucent
234 x 140	STDIV214	Translucent

+Add Spring Handles		
Width (mm)	Code	Colour
117	STHAN117	Chrome
234	STHAN234	Chrome



Perfect solution for production environments

KANBAN SHELVING

Rivet Racking Kanban is our solution for production line-side supply systems, where sloping shelves present containers for easy access and at the right height for operatives.

This can reduce costs and increase efficiency for manufacturing operations or inventory management. The two bin arrangement simplifies stock rotation and replenishment. When the front bin is removed the bin behind takes its place, leaving a space that is clearly identified for refilling on the next inspection.

- 80 KG Shelf Load
- 5 YEAR Guarantee
- 5 DAYS Delivery

Discover the full Rivet range

COMPLETE RIVET RACKING RANGE PAGES 12 - 45

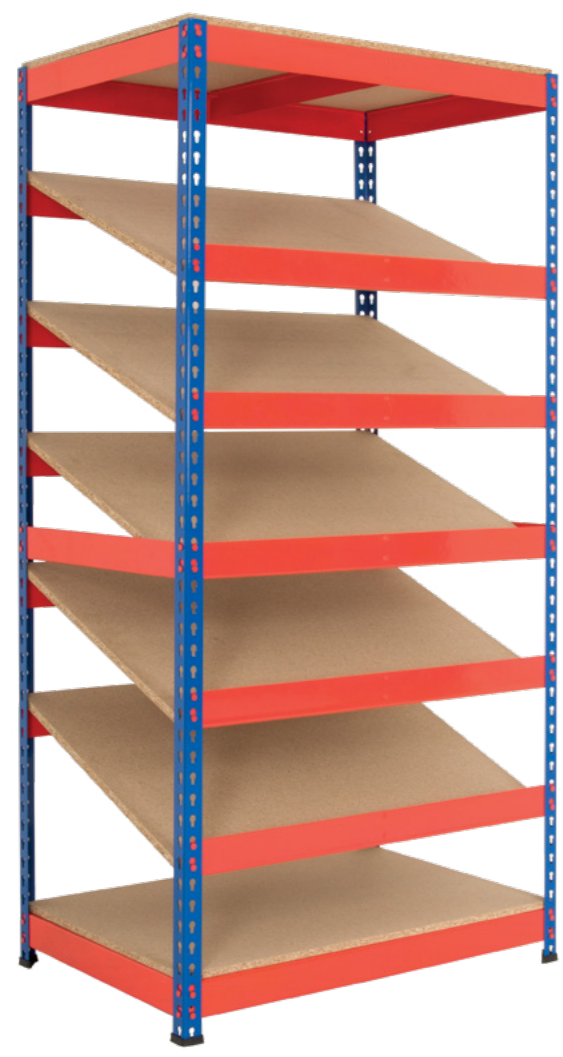

Kanban Shelving with 3 Sloping Shelves

Description	H x W x D (mm)	Code
Kanban shelving no bins	1830 x 915 x 610	RRKB03/MT
Extra shelf (no bins)	915 x 610	RRKB/0906

i Price includes complete Kanban bay with 3x sloping shelves, top and bottom shelves. Euro containers shown not included!

Kanban Shelving with 5 Sloping Shelves

Description	H x W x D (mm)	Code
Kanban shelving no bins	1830 x 915 x 610	RRKB01/MT
Extra shelf (no bins)	915 x 610	RRKB/0906

i Price includes complete Kanban bay with 5x sloping shelves, top and bottom shelves.

Our solution for production line side supply systems
 Kanban Shelving with Plastic Bins and Shelf Trays



Kanban Shelving with Picking Bins

H x W x D (mm)	Bin	Code
1830 x 915 x 610	60x ARTB30	RRKB01

i Includes complete Kanban bay with 5 sloping + top + bottom shelves and 60 x ARTB30 plastic bins.

Bay Colour Options

- For Blue Uprights with Orange Shelves add /BO to the end of your chosen price code.
- For Blue Uprights with Grey Shelves add /BG to the end of your chosen price code.

Kanban Shelving with Shelf Trays

H x W x D (mm)	Bin	Code
1830 x 915 x 610	70x ST3109	RRKB02

i Includes complete Kanban bay with 5 sloping + top + bottom shelves and 70 x ST3109 shelf trays.

- 80 KG Shelf Load
- Warehouse
- Storeroom
- Workshop

Highly configurable divider system



Semi-open Fronted

SHELF BINS

Are you in need a strong, robust and versatile bin storage solution, at a competitive price? – then look no further.

Our range of Shelf Bins have been designed to offer a range of bins in "Big Sizes" for storing large parts or increased volumes. They can fit both small parts shelving systems as well as larger bays, such as Rivet or Longspan.

They have many new features, such as internal dividers that securely locate in up to 7 different locations. There is also an integral back stop allowing the bin to be suspended out from the shelving, for ease of picking.

With a semi-open front and a large labelling area below, ensures items can be identified quickly. The bins are available in Blue shockproof plastic and can be nested when not in use to save space.

Plastic Bin Features

- 1 Integral back stop
- 2 Profiled sides for extra strength
- 3 Nestable design – space saving
- 4 Large labelling area
- 5 Semi-open fronted design
- 6 7 divider positions in each bin
- 7 Dividers positively slot into the bin

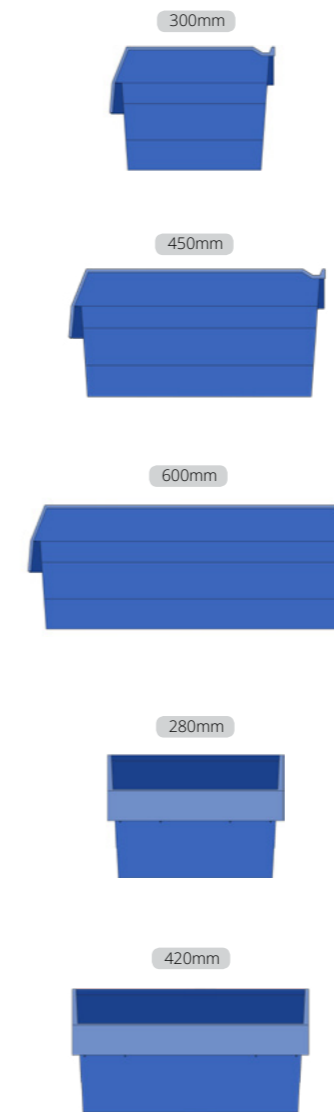

Shelf Bins & Additional Dividers

Without Dividers

With Dividers

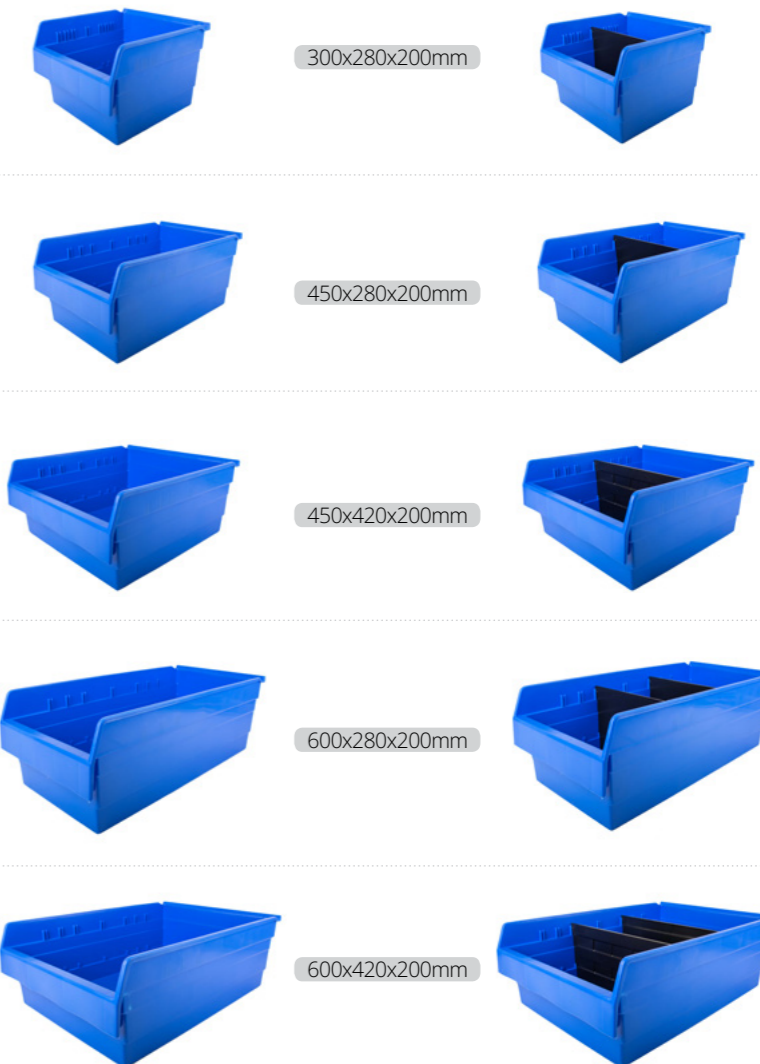

Shelf Bins		
D x W x H(mm)	Code	Colour
300x280x200mm	SFB302820	Blue
450x280x200mm	SFB452820	Blue
450x420x200mm	SFB454220	Blue
600x280x200mm	SFB602820	Blue
600x420x200mm	SFB604220	Blue

Add Dividers		
W x H(mm)	Code	Colour
280x200mm	SFD2820	Black
420x200mm	SFD4220	Black



Heights

Height (mm)
200



Widths

Widths (mm)
280, 420



Depths

Depths (mm)
300, 450, 600



Application

Environment
Hospitals, Storeroom,
Workshop, Office, Warehouse

Usage
Part Picking



Construction

High Strength
Polypropylene in Blue



Loadings

Maximum
4 kgs suspended
load from shelving

Maximum
18kgs static load
within shelving



Delta Racking Bays with Bins



Delta Shelving with 280mm Shelf Bins

H x W x D (mm)	Bin Qty	Code
1930 x 902 x 300	21	DTSFB03A
1930 x 902 x 450	21	DTSFB04A
1930 x 902 x 600	21	DTSFB06A
1930 x 902 back cladding	-	DT05/1909/WH

Includes Delta bay with open backs (except for X bracing) with 8 shelf levels and 21 No. shelf bins 280mm wide. (Dividers not included)

Delta Shelving with 420mm Shelf Bins

H x W x D (mm)	Bin Qty	Code
1930 x 902 x 450	14	DTSFB04B
1930 x 902 x 600	14	DTSFB06B
1930 x 902 back cladding	-	DT05/1909/WH

Includes Delta bay with open backs (except for X bracing) with 8 shelf levels and 14 No. shelf bins 420mm wide. (Dividers not included)

Delta Shelving with Mixed 280mm & 420mm Shelf Bins

H x W x D (mm)	Bin Qty	Code
1930 x 902 x 450	17	DTSFB04C
1930 x 902 x 600	17	DTSFB06C
1930 x 902 back cladding	-	DT05/1909/WH

Includes Delta bay with open backs (except for X bracing) with 8 shelf levels and 9 No. 280mm and 8 No. 420mm wide shelf bins. (Dividers not included)

Rivet Racking Bays with Bins



Rivet Racking with 280mm Shelf Bins

H x W x D (mm)	Bin Qty	Code
1980 x 915 x 305	18	RRSFB03A
1980 x 915 x 457	18	RRSFB04A
1980 x 915 x 610	18	RRSFB06A

Includes Rivet Racking bay with 7 shelf levels and 18 No. shelf bins 280mm wide. (Dividers not included)

Rivet Racking with 420mm Shelf Bins

H x W x D (mm)	Bin Qty	Code
1980 x 915 x 457	12	RRSFB04B
1980 x 915 x 610	12	RRSFB06B

Includes Rivet Racking bay with 7 shelf levels and 12 No. 420mm wide shelf bins. (Dividers not included)

Rivet Racking with mixed 420mm & 280mm Shelf Bins

H x W x D (mm)	Bin Qty	Code
1980 x 915 x 457	15	RRSFB04C
1980 x 915 x 610	15	RRSFB06C

Includes Rivet Racking bay with 7 shelf levels and 9 No. 280mm and 6 No. 420mm wide shelf bins. (Dividers not included)



Label and Ticket Holders



Magnetic Label Holders and Self Adhesive Label Holders

Available in self-adhesive or magnetic formats, these holders keep labels, barcodes, and location markers protected and readable, ensuring a long-lasting and effective labelling system. Each holder is supplied in pre-cut lengths and come complete with card and cover strip.

- **Instant visible rack identification**
Choose either magnetic or self-adhesive
- **Two Fixing Options**
Magnetic holders are ideal for applications where regular changes are required, or cold stores to temperatures of -30 degrees. Self-adhesive is great for a more permanent labelling solution.
- **Other sizes available from stock**
Pre-cut lengths for quick despatch
- **5, 10 & 50 metre rolls are also available**
to be cut to size with scissors
- **Scannable & Barcode-Compatible**
Transparent cover allows easy barcode scanning.
- **Protects Label from Dirt & Damage**
The clear PVC cover strip shields labels from dust, spills, and wear and tear.



Magnetic Label Holders

H x W (mm)	Code	Pack
20 x 80	ML28X	100
30 x 80	ML38	100
40 x 80	ML48	100
50 x 80	ML58	100
60 x 100	ML610	100
60 x 200	ML620	50
70 x 100	ML710	100
70 x 200	ML720	50
80 x 200	ML820	50
40mm x 10m	MLR4/10	1 Roll

Black PVC extrusion

Self Adhesive Label Holders

H x W (mm)	Code	Pack
15 x 80	AL18	100
30 x 80	AL38	100
50 x 80	AL58	100
15 x 1000	AL1/10	10
30 x 1000	AL3/10	10
50 x 1000	AL5/10	10

White PVC extrusion

i Pricing on pages 126 - 131 excludes delivery



Magnetic Ticket Holders and Self Adhesive Ticket Holders

Designed to be used with printed labels and barcodes, the easy pull forward front panel makes changing labels easy. No need to remove the label when scanning.

- **Instant visible rack identification**
Choose either magnetic or self-adhesive
- **Two Fixing Options**
Magnetic holders are ideal for applications where regular changes are required, or cold stores to temperatures of -30 degrees. Self-adhesive is great for a more permanent labelling solution
- **Many sizes available from stock**
Pre-cut lengths for quick despatch
- **Non-standard sizes cut to your length**
requirements are available
- **Scannable & Barcode-Compatible**
Transparent cover allows easy barcode scanning.
- **Protects Label from Dirt & Damage**
The clear PVC front shields labels from dust, spills, and wear and tear.
- **Designed for Industrial Use**
These heavy-duty holders stand up to daily warehouse use.



Magnetic Ticket Holders

H x W (mm)	Code	Pack
25 x 100	TS210M	100
25 x 200	TS220M	50
25 x 1000	TS25M/10	10
38 x 100	TS310M	100
38 x 200	TS320M	50
38 x 1000	TS38M/10	10
54 x 100	TS510M	100
54 x 200	TS520M	50
80 x 100	TS810M	100
80 x 200	TS820M	50
80 x 1000	TS80M/10	10
125 x 200	TS125M/200	50
125 x 1000	TS125M/10	10

Clear PVC with magnetic strip

Self-Adhesive Ticket Holders

H x W (mm)	Code	Pack
25 x 100	TS210	100
25 x 200	TS220	50
25 x 1000	TS25/10	10
38 x 100	TS310	100
38 x 200	TS320	50
38 x 1000	TS38/10	10
54 x 100	TS510	100
54 x 200	TS520	50
54 x 1000	TS54/10	10
80 x 100	TS810	100
80 x 200	TS820	50
80 x 1000	TS80/10	10

Clear PVC with aggressive adhesive backing

Magnetic 'Easy Wipe' Racking Strip



Our magnetic easy wipe racking strip is available from stock in 12 sizes and 5 gloss colours for a cost effective and high visibility identification system. The 'easy wipe' Racking strip is easily cut to size and is 'write on - wipe off' when used with a wet wipe pen.

Magnetic Easy Wipe Location Strips

H (mm) x L (m)	Code
10mm x 10m	MSR1
15mm x 10m	MSR15
20mm x 10m	MSR2
25mm x 10m	MSR25
30mm x 10m	MSR3
40mm x 10m	MSR4
50mm x 10m	MSR5
60mm x 10m	MSR6
70mm x 10m	MSR7
80mm x 10m	MSR8
90mm x 10m	MSR9
100mm x 10m	MRS10

Available in blue (B), green (G), red (R), white (W), and yellow (Y)

Magnetic Easy Wipe Location Markers

White magnetic location markers supplied in pre cut single sized pieces. Use a wet-wipe marker pen, write on, update and move when required.

These pre-cut markers offer a quick and easy high visibility system of identifying locations, products or stock quantities etc.

For best results please use a wet wipe marker pen, the text can then be simply cleaned using a damp cloth - using permanent markers will require a strong alcohol based cleaner.



Magnetic Easy Wipe Location Markers

H x W (mm)	Code	Pack	Colour
20 x 80	LM28W	100	White
30 x 80	LM38W	100	White
40 x 80	LM48W	100	White
50 x 80	LM58W	100	White
56 x 105	LM105W	100	White
50 x 150	LM515W	100	White
90 x 210	LM219W	10	White

Warehouse Labelling and Install



We can carry out labelling installations in either new or occupied warehouses, working around the current operations.

Our service includes advice and consultation

in the planning stage, hire of equipment, and installation by trained and qualified personnel.

To book your consultation please call our sales office.



racksack®

racksack® is a practical, space-saving way to sort and dispose of waste in the workplace. Originally designed to fit onto the end of racking systems with S hooks, they're ideal for use in warehouses, factories, and other industrial settings. The range has since expanded to include rollcage, trolley, mini, and nano styles.

- racksack® can be bespoke overprinted with different designs, including company logos, prices available upon request
- Supplied with 2x S hooks. Optional bungee loop or wall-mounted hook fixings also available.



racksack®

Type	Code
racksack® (Pack of 1)	RSB1/XX
racksack® (Pack of 5)	RSB5/XX
racksack® (Pack of 10)	RSB10/XX

Replace /XX with required usage diagram
General Waste (GW), Mixed Paper & Card Clear (MP), Cardboard (C), Plastic Only Clear (P), Plastic Strapping (PS), Shrink Wrap (SW), Mixed Recycling (MR),

racksack® Clear

Type	Code
racksack® Clear (Pack of 1)	RSCL1/XX
racksack® Clear (Pack of 5)	RSCL5/XX
racksack® Clear (Pack of 10)	RSCL10/XX

Replace /XX with required usage diagram
General Waste (GW), Mixed Paper & Card Clear (MP), Cardboard (C), Plastic Only Clear (P) and Shrink Wrap (SW)

racksack® mini

- Designed for workstations and workbenches including packing benches; picking stations; assembly stations and desks
- Available in 4 text or 3 symbol-only design options, including a blank option
- Supplied with 2x S hooks. Optional bungee loop or wall-mounted hook fixings also available.
- 880mm high x 600mm wide and available in all waste categories



racksack® mini

Type	Qty	Code
Racksack® mini - Blank	1	RSMB1/BK
Racksack® mini - General Waste	1	RSMB1/GW
Racksack® mini - Mixed Paper & Card	1	RSMB1/MP
Racksack® mini - Plastic Only	1	RSMB1/P
Racksack® mini - Mixed Recycling	1	RSMB1/MR
Racksack® mini - Blank	5	RSMB5/BK
Racksack® mini - General Waste	5	RSMB5/GW
Racksack® mini - Mixed Paper & Card	5	RSMB5/MP
Racksack® mini - Plastic Only	5	RSMB5/P
Racksack® mini - Mixed Recycling	5	RSMB5/MR
Racksack® mini - Blank	10	RSMB10/BK
Racksack® mini - General Waste	10	RSMB10/GW
Racksack® mini - Mixed Paper & Card	10	RSMB10/MP
Racksack® mini - Plastic Only	10	RSMB10/P
Racksack® mini - Mixed Recycling	10	RSMB10/MR

racksack® nano

- Designed for use with forklift trucks and pallet truck handles
- Hook and loop fastening eliminates chance of snagging
- Supplied with bungee loop fixing
- Capacity: 32.8L
- Weight Capacity: Up to 25kgs
- Size: 600mm (H) x 450mm (W)
- Other designs and special prints available on request



racksack® nano

Type	Qty	Code
Racksack® Nano - Blank	1	RSNB1/BK
Racksack® Nano - Blank	5	RSNB5/BK
Racksack® Nano - Blank	10	RSNB10/BK
Racksack® Nano - General Waste	1	RSNB1/GW
Racksack® Nano - General Waste Symbol only	1	RSNB1/GWNT
Racksack® Nano - General Waste	1	RSNB5/GW
Racksack® Nano - General Waste Symbol only	5	RSNB5/GWNT
Racksack® Nano - General Waste	10	RSNB10/GW
Racksack® Nano - General Waste Symbol only	10	RSNB10/GWNT
Racksack® Nano - Mixed Card & Paper	1	RSNB1/MP
Racksack® Nano - Mixed Card & Paper only	1	RSNB1/MPNT
Racksack® Nano - Mixed Card & Paper	5	RSNB5/MP
Racksack® Nano - Mixed Card & Paper only	5	RSNB5/MPNT
Racksack® Nano - Mixed Card & Paper	10	RSNB10/MP
Racksack® Nano - Mixed Card & Paper only	10	RSNB10/MPNT
Racksack® Nano - Plastics	1	RSNB1/P
Racksack® Nano - Plastics Symbol only	1	RSNB1/PNT
Racksack® Nano - Plastics	5	RSNB5/P
Racksack® Nano - Plastics Symbol only	5	RSNB5/PNT
Racksack® Nano - Plastics	10	RSNB10/P
Racksack® Nano - Plastics Symbol only	10	RSNB10/PNT

Graphic Floor Signs



- Designed to highlight warnings or special requirements
- Large 430mm diameter - easily visible from a distance
- 35 designs to choose from
- Tested to R10 slip-resistance

frames4floors®



frames4floors®

- Tough, flat, colour coded floor identification frames
- Ideal for identifying bulk locations or important information

Applied in 4 Easy Steps

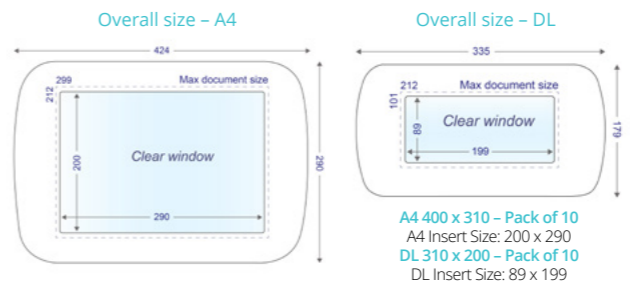

A4 - 400 x 310 - Pack of 10		DL 310 x 200 - Pack of 10	
Colour	Code	Colour	Code
Blue	FF4B/10	Blue	FFDLB/10
Black	FF4BK/10	Black	FFDLBK/10
Green	FF4G/10	Green	FFDLG/10
Red	FF4R/10	Red	FFDLR/10
Yellow	FF4Y/10	Yellow	FFDLY/10
Yel/Blk	FF4BY/10	Yel/Blk	FFDLBY/10
Mixed	FF4MIX/10	Mixed	FFDLMIX/10

Mixed - 2 of each, blue, black, green, red, yellow



Floor Signal Markers



- Highly visible signal markers for walkways, pallet storage and general floor marking highlight walkways, traffic flow, pallet positions and general marking on the warehouse floor
- Suitable for application onto a clean, flat, sealed surface
- Available in six colours

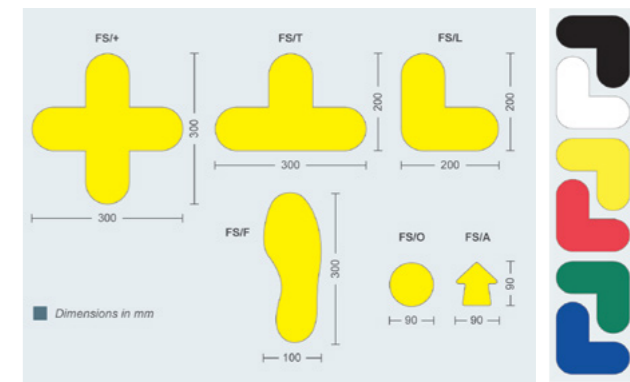

Floor Signalling		
Description	Code	Pack
Cross	FS/+	10
T Shape	FS/T	10
L Shape	FS/L	10
Circle	FS/O	100
Arrow	FS/A	100
Feet (5 left & 5 Right)	FS/F	10

Colours available - Black, White, Yellow, Red, Green, Blue



ImpactSAFE Heavy Duty Bollard

This advanced range of Heavy Duty Bolt-Down Bollards has shock absorbing rubber buffers to take the force of impacts away from the slab and fixings.

Our Heavy Duty Bolt-Down Bollards offer exceptional impact protection with industrial steel cores and innovative ImpactSAFE shock-absorbing rubber buffers, designed to deflect impact force away from slabs and fixings. Available in 1000mm, 1300mm, and 1600mm heights, each bollard includes a slide-over polymer cover kit, eliminating the need for repainting, and 50mm reflective bands for high visibility.

Installation is fast and secure using bolt-down fixings and flush finish safety-plus floor anchors, which reduce trip hazards and prevent dirt build-up. These bollards are ideal for safeguarding entrances, service zones, and high-traffic areas across commercial and industrial sites.

The 168mm diameter steel cores come with galvanized base plates and are available in five bright colour options. Fully tested to PAS 13 standards, these bollards deliver long-term durability, reduced maintenance, and enhanced safety.

A full range of bolt-down and potted (cast-in) options is also available upon request.

- Heavy Duty Bollard available in 1000mm, 1300mm and 1600mm height options
- Bolt-Down fixings, with polymer cover kits and 50mm reflective bands
- Industrial steel core bollards with ImpactSAFE shock absorbing buffers to arrest impact force
- Easy to fit, slide-over Polymer cover kits to eliminate need for repainting
- Flush finish safety-plus floor anchors to reduce trip hazards and dirt collection

Description	Height (mm)	Colour	Code
ImpactSAFE Heavy Duty Bollard	1,000	Yellow & Black	ISB-1000YB
ImpactSAFE Heavy Duty Bollard	1,300	Yellow & Black	ISB-1300YB
ImpactSAFE Heavy Duty Bollard	1,600	Yellow & Black	ISB-1600YB



What is the PAS 13 code of practice?

PAS 13 is the only global code of practice for industrial safety barriers. It is intended to be used as a reference point for engineers, architects, contractors, health and safety professionals, as well as any other stakeholders involved in the design, construction, deployment and maintenance of safety barriers. The code is based on the principles of risk assessment and recommends selecting the appropriate safety barriers based on the potential hazards and risks in the surrounding area.

Compliance with PAS 13 helps to ensure that the installed safety barriers are effective in protecting people and assets from potential hazards and ultimately minimising the risk of accidents and injuries.



Single & Double Bumper Barriers



Low maintenance High Density Polyethylene (HDPE) plastic barriers only need replacing when frequent, major impact has occurred.

Unlike metal barriers, there is minimal floor damage when impact occurs, saving maintenance costs long term. Fully recyclable & non-toxic.

Suitable for use in food production facilities and freezer environments. Combines strength & visibility to maximise space also protects against large MHE within busy warehouses.

- Made from Highly durable plastic
- Flexes on impact and reforms shape
- Variety of highly visible colours available
- Use in ambient, chilled, and freezer environments

Description	Length (mm)	Colour	Code
Single bumper barrier	1,900	Safety Yellow & Grey	LBBS19/SYG
Single bumper barrier	3,400	Safety Yellow & Grey	LBBS34/SYG
Single bumper barrier	4,900	Safety Yellow & Grey	LBBS49/SYG
Double bumper barrier	1,900	Safety Yellow & Grey	LBBD19/SYG
Double bumper barrier	3,400	Safety Yellow & Grey	LBBD34/SYG
Double bumper barrier	4,900	Safety Yellow & Grey	LBBD49/SYG

Essential, Core, Plus: One range, three levels of protection.



Everyday protection for standard industrial environments.

Ideal for:

- Light to moderate vehicle traffic
- Standard forklifts and pallet trucks
- General warehouse and production areas
- Projects where budget efficiency is key



Durable protection for busy, high-activity sites.

Ideal for:

- High-traffic warehouse aisles
- Regular forklift and MHE activity
- Loading, picking, and despatch areas
- Sites requiring a balance of performance and value



Maximum protection for high-risk, safety critical areas.

Ideal for:

- Heavy vehicle and HGV traffic
- High-risk or safety-critical zones
- Areas with repeated high-impact exposure
- Sites prioritising maximum protection and lifespan



Pedestrian Barrier

Brandsafe



PLUS



A simple solution to protect and segregate pedestrians and MHE

- Highly durable plastic for long lasting protection
- Variety of highly visible colours available
- Use in ambient, chilled, and freezer environments
- Further colour options available on request: Yellow posts with Black Rails or Safety Yellow

Description	Length (mm)	Colour	Code
3 rail pedestrian barrier 1500mm length	1,500	Safety Yellow & Grey	PB315/SYG
3 rail pedestrian barrier 3000mm length	3,000	Safety Yellow & Grey	PB330/SYG
3 rail pedestrian barrier 4500mm length	4,500	Safety Yellow & Grey	PB345/SYG

Bumper Pedestrian Barriers

Brandsafe

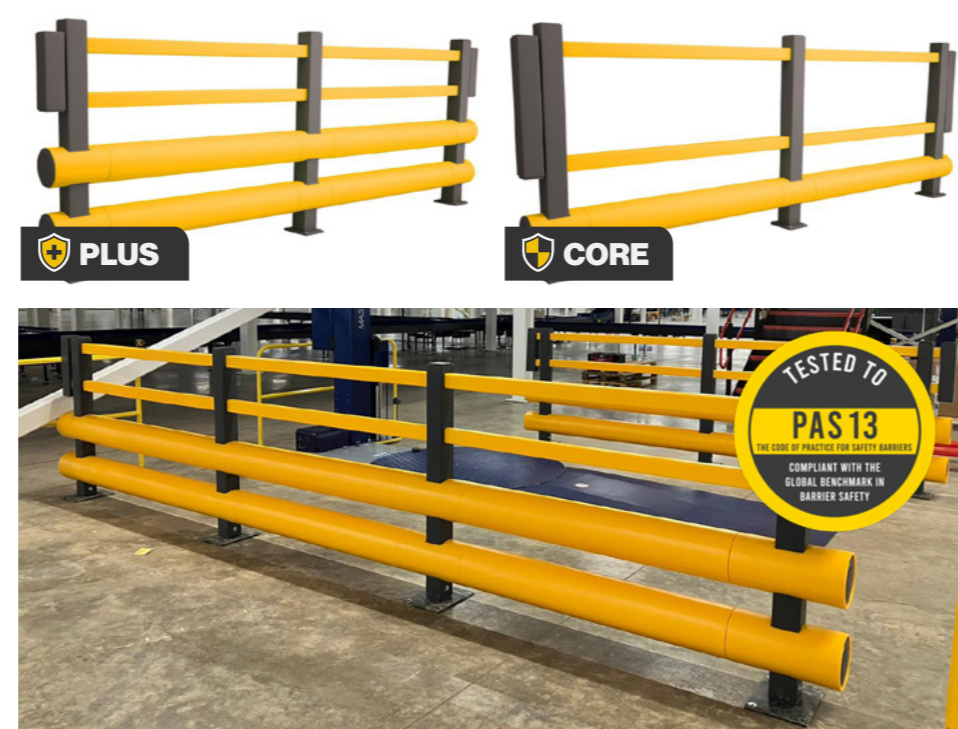

Low maintenance High Density Polyethylene (HDPE) plastic barriers only need replacing when frequent, major impact has occurred. Pedestrian barriers with bumpers offer extra deflection and strength to increase safety of pedestrians.

- Highly durable plastic for long lasting protection
- Flexes on impact and reforms shape
- Variety of highly visible colours available
- Use in ambient, chilled, and freezer environments

Description	Length (mm)	Colour	Code
Single bumper pedestrian barrier	1,900	Safety Yellow & Grey	PBBS19/SYG
Single bumper pedestrian barrier	3,400	Safety Yellow & Grey	PBBS34/SYG
Single bumper pedestrian barrier	4,900	Safety Yellow & Grey	PBBS49/SYG
Double bumper pedestrian barrier	1,900	Safety Yellow & Grey	PBBD19/SYG
Double bumper pedestrian barrier	3,400	Safety Yellow & Grey	PBBD34/SYG
Double bumper pedestrian barrier	4,900	Safety Yellow & Grey	PBBD49/SYG

Pedestrian Safety Gates

Brandsafe

Safe and easy to use pedestrian access for any barrier system

Manufactured from low maintenance, High Density Polyethylene (HDPE) plastic, these gates only need replacing when frequent, major impact occurs. Unlike metal gates, there is minimal floor damage upon impact, saving long-term maintenance costs. Available in a range of striking, high-visibility colours that are easily detectable, they prevent accidents before they happen. Fully recyclable and non-toxic, these gates are suitable for use in food production facilities and freezer environments. They align perfectly with our safety barrier range, including Pedestrian Safety Barriers (SEG+), Guardrail Systems (MHE / PIT), Single Bumper Pedestrian Barriers, Double Bumper Pedestrian Barriers.

- Separating forklifts from pedestrian routes
- Flexes on impact and reforms shape
- Use in ambient, chilled, and freezer environments
- Compatible with our range of safety barrier systems



Description	Colour	Code
Safety Gate	Safety Yellow & Grey	BS-PB-PSG

Floor Rail Bumpers

Brandsafe



ESSENTIAL

Protect your aisles of racking from low level accidental impact damage with this durable Floor Rail Bumper system.

The Floor Rail Barrier is a robust and efficient solution designed to enhance racking protection in various industrial environments. Manufactured from high-density polyethylene (HDPE) polymer, these barriers provide durable and reliable protection, making them ideal for safeguarding infrastructure against impacts from material handling equipment (MHE).

Features and Benefits:

- Highly durable plastic for long lasting protection
- Flexes on impact and reforms shape
- Use in ambient, chilled and freezer environments
- Bespoke options available upon request



Description	Length (mm)	Colour	Code
Floor rail bumper	1,200	Safety Yellow	KBB12/SYG



Safety Bollard

Brandsafe



Unlike metal bollards, impact causes minimal floor damage, helping reduce long-term maintenance costs.

Adding strength and presence to corners, structures and entryways.

Fully recyclable and non-toxic. Suitable for use in food production facilities and freezer environments.

- Highly durable plastic with a steel core for long lasting protection
- Variety of highly visible colours available
- Use in ambient, chilled, and freezer environments

Description	Height (mm)	Colour	Code
Safety bollard	600	Safety Yellow & Grey	HDB60/SYG
Safety bollard	900	Safety Yellow & Grey	HDB90/SYG
Safety bollard	1,200	Safety Yellow & Grey	HDB12/SYG

ImpactSAFE Protection Posts

Brandsafe

Low-cost door and services protection

Medium Duty Protection Post - Ideal for keeping pallet trucks and MHE away from equipment, vulnerable services and building projections, which would otherwise result in personnel safety issues and impact damage. This product combines the strength of a steel core and baseplate, with the impact absorption of a rubber buffer. Sleeved in highly visible Safety Yellow Polyethylene, our Protection Posts are low-maintenance, with no requirement for

repainting going forward.

- Strong and robust protection post
- 600mm, 800mm and 1000mm high post options
- Highly visible to drivers and pedestrians
- No need for repainting with Yellow polyethylene sleeve
- Supplied with rubber ImpactSAFE Buffers to absorb shock



ESSENTIAL

Description	Height (mm)	Colour	Code
ImpactSAFE Protection Post	600	Yellow & Black	ISP-600YB
ImpactSAFE Protection Post	800	Yellow & Black	ISP-800YB
ImpactSAFE Protection Post	1,000	Yellow & Black	ISP-1000YB

Heavy Duty Potted Bollard

Brandsafe

A robust and impact-absorbing bollard system designed to protect your warehouse or loading bay from heavy vehicles

This bollard is made from high-quality mild steel and hot dip galvanized to BS EN ISO 1461 standards. It's engineered to withstand impact from material handling equipment, ensuring that your floor anchors and protective slab remain safe and secure.

Installation requires some excavation to the required depth of the 'potted' bollard section, and concrete can be used to finish the floor level neatly. The Potted Bollard is a heavy-duty ground-sunk design that's perfect for warehouses, loading bays, and other industrial settings where heavy vehicles are in use.

By investing in the Heavy Duty Potted Bollard, you can ensure the safety and security of your workplace, while also protecting your equipment and flooring from damage.

- Diamond core drill and cast-in potted bollards with galvanised steel core
- Finished with polymer bollard cover kits for high-visibility and no-paint maintenance benefits
- 500mm potted depth
- Bollards incorporate 50mm reflective silver band
- Ideal for external level access loading doors, where HGV trailers reverse in and out

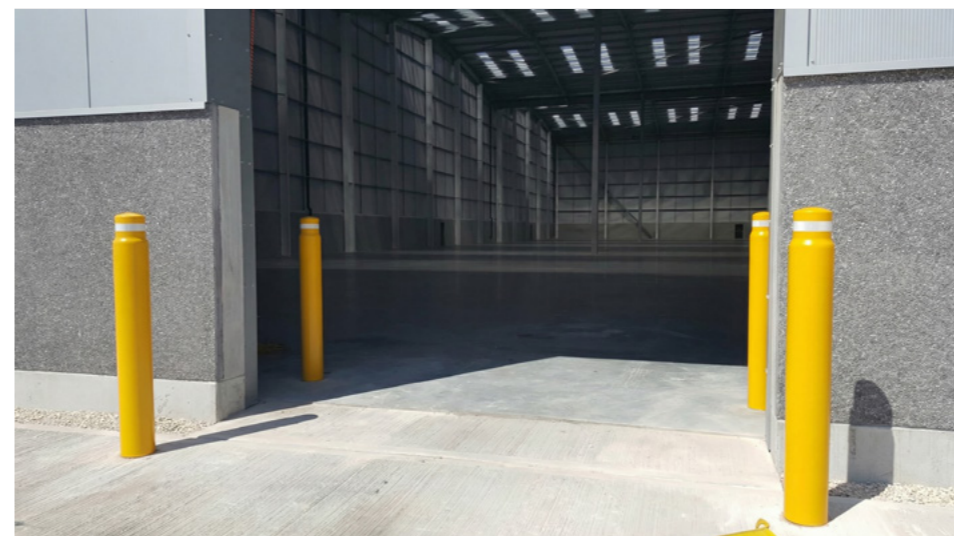

Description	Above ground height (mm)	Overall Height (mm)	Core Diameter (mm)	Overall Diameter with Cover (mm)	Cover Colour	Code
Potted Bollard	960	1,460	168	210	All Yellow	BKP-HD960YY
Potted Bollard	1,260	1,760	168	210	All Yellow	BKP-HD1260YY
Potted Bollard	1,560	2,060	168	210	All Yellow	BKP-HD1560YY

Flexible Delineators

Brandsafe

Safe and easy to use pedestrian access for any barrier system

Flexi-delineators designed to route vehicles safely round your industrial facility. They are ideal for segregation of traffic routes with risk of vehicle impact where barriers are not achievable or desired.

Highly visible with 4 no. Reflective Bands to promote night time safety. Soft under vehicle impact - they will crush and bend returning to original state without damage to the delineator or damage to the vehicles.

- Separating forklifts from pedestrian routes
- Flexes on impact and reforms shape
- Use in ambient, chilled, and freezer environments
- Compatible with our range of safety barrier systems

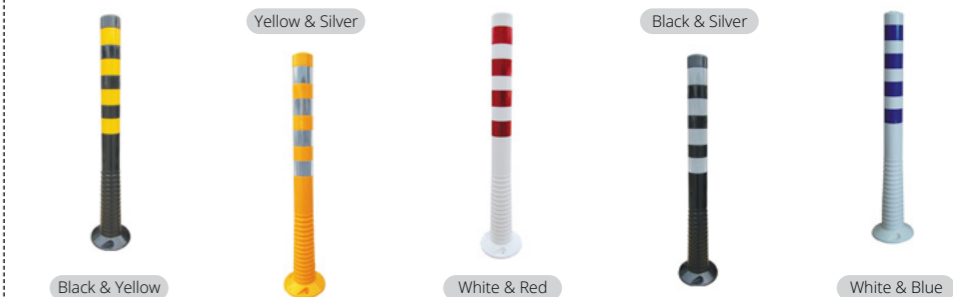

Description	Colour	Code
Flexi-Delineator	Black & Yellow	FD-1000-BY
Flexi-Delineator	Yellow & Silver	FD-1000-YS
Flexi-Delineator	White & Red (MOQ may apply)	FD-1000-WR
Flexi-Delineator	Black & Silver	FD-1000-BS
Flexi-Delineator	White & Blue (MOQ may apply)	FD-1000-WB



PolyWRAPs Column Protectors **Brandsafe**

Designed to make columns highly visible to MHE/PIT traffic operators. Clashes with columns and the protector will cushion the impact. The tough Polyethylene makes this the product of choice for most industrial facilities - no fixtures to the slab this is a simple clam-shell fitment.

The PolyWRAP is suitable for structural columns and high risk mezzanine columns where forklifts and power trucks operate.

- Designed to fit a wide range of common structural steel columns to provide impact protection
- Vibrant colours to make them highly visible to drivers
- Simple clam-shell design make it quick and easy to install and secure with ratchet straps
- Stackable design with impact absorbing cores reduces the impact damage done to vehicles



Code	Suits Column Size (mm)
PW-200	210
PW-300	320
PW-370	380
PW-420	420
PW-600	620
PW-900	920

PolyWRAP SpaceSavers **Brandsafe**

PolyWRAP SpaceSaver Column Protectors are quick and easy to install and are ideal for protecting mezzanine columns without taking up valuable floor space:

- Designed to make columns highly visible to traffic operators to see the column and avoid hitting it
 - Specifically designed to suit mezzanine columns where space is at a premium
 - PolyWRAP SpaceSaver column protector will cushion the impact, avoiding damage to both the vehicle and the column itself
 - Tough polyethylene construction makes this the product of choice for most industrial facilities
- Simple clam-shell design that requires no fixings to install
- The performance of the PolyWRAP SpaceSaver will depend on vehicle speeds, weights and condition of impact



Code	Suits Column Size (mm)
PWSS-100	100
PWSS-120	120
PWSS-150	150
PWSS-200	200
PWSS-250	250

Sign & Lamp PostWRAPs **Brandsafe**

A 2 piece clam-shell designed Sign Post Protector with high density foam impact cores. Manufactured from tough Polyethylene with high density foam absorbing impact core. Available in 5 colour options with 3 no. diamond grade reflective bands for night time visibility. Each protector can be simply raised up to gain access to the security hatch for maintenance access.

- Quick and easy to install on-site
- Low-cost solution avoids unnecessary and expensive excavation associated with potted steel solutions
- The system incorporates an absorbing core that will take vehicle nudges and low speed impact avoiding damage to vehicle bumpers and/or the sign post itself
- Tough Polyethylene construction, will stand up to all weather conditions



- Unique Clam Shell system with security fixings
- Diamond grade 50mm hi-vis reflectors
- 1250mm High, outer diameter 285mm – max UK Manufacture internal diameter 210mm
- Can be used 'Double Stacked' at 2500mm high to suit HGV cab level visibility
- Manufactured in the UK from Polyethylene

Code	Colour
BS-SPW-1250-YS	Yellow & Silver
BS-SPW-1250-RW	Red & White
BS-SPW-1250-BY	Black & Yellow
BS-SPW-1250-BW	Black & White
BS-SPW-1250-GW	Green & White

SoftWRAPs **Brandsafe**

Eliminate the risk of personnel injury in your industrial facility with the fitment of SoftWRAP column protection. A high tear resistant yellow textured vinyl canvas encasing polyethylene based medium density foam cores for easy wrap-around fitment to i-Beams, secured by 50mm Velcro seam. Typically installed at 1100mm or 1800mm heights.

Code	Dimensions (mm)
SWC-1100-Y	1100mm x 300mm x 300mm
SWC-1800-Y	1800mm x 300mm x 300mm

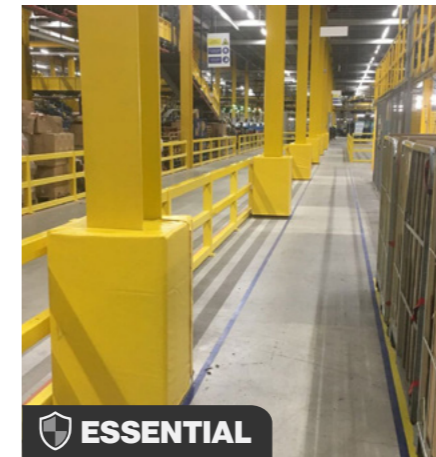

CornerWRAP **Brandsafe**

CornerWRAP makes exposed corners highly visible, while reflective chevron stripes provide excellent night-time visibility:

- **Medium Duty CornerWRAP** is an ideal solution for protecting vulnerable door opening corners
- **Heavy Duty CornerWRAP** is a perfect solution for exposed corners and header beams, highlighting vulnerable corners and providing a cushion under impact:
- Protects people and buildings from harmful effects
- Suitable for steel, brick, block or precast concrete walls



Code	Colour	Description
CW-LD800-BY	Black & Yellow	Medium Duty CornerWRAP
CW-LD890-BY	Black & Yellow	Heavy Duty CornerWRAP

EdgeWRAPs **Brandsafe**

Provides safety and visual awareness to sharp edges in the workplace

- Easy to install foam edge protection
- Protect pedestrians from injury to heads and limbs
- Makes exposed sharp edges visible and safe
- Protects exposed edges from damage



Type	Code	Shape Description	Cutout Dimensions
A	EW-40-A	Cutout circle	Not specified
B	EW-40-B	Push-fit circle	20 x 8mm
C	EW-40-C	Semi-circle	Flat Edge: 32mm
D	EW-6020-D	Rectangle	Not specified
E	EW-40-E	Push-fit trapeze	20 x 8mm





Workplace Projects Industrial Fit-Out

The design of a warehouse clearly has a direct effect on the efficiency of the entire business. With such a critical area of the supply chain it makes perfect sense to get expert guidance and support. We can provide advice on warehouse design inside and out, we will listen to you and what your organisation needs and supply the complete solution.

- Industrial partitions
- Kitchen and welfare facilities
- Mezzanine floors
- Storage systems
- Materials handling
- Live storage systems
- Roller and belt conveyors
- Picking and packing equipment



Book your annual Rack Inspections to keep safe & operational



Inspections

By ensuring that the racking system is in good condition, annual inspections can improve safety, productivity, and compliance, while minimising costs and liability.

An experienced and qualified inspector will walk you around any identified situations in the report, to spend the time to assist you with the information you need to ensure your storage systems are safe and compliant to the latest health and safety legislation. This will help to reduce risk and prolong the lifespan of your racking...ultimately saving you money!

On completion of an electronic inspection from a PUWER & SEMA accredited inspector, you will have a clear & concise digital next day report, highlighting;

- Priority rated actions to SEMA's Red, Amber and Green classifications.
- Recommendations that will prolong the life of your storage equipment.
- Guidance to improve workforce safety such as housekeeping.

Book an inspection to remain compliant and to safeguard your warehouse

Training

Upskill your team to better support maintenance, safety and operations

Having the inhouse personnel with the skills to quickly spot, assess and repair your racking, can have a significant savings, improve productivity and your profitability.

Does your team understand what to look for and why?

Anything can happen to your warehouse in between annual inspections, why leave it to chance? Regular internal checks of your racking ensures that it stays safe to support your stock and remains structurally sound.

Does your team have the skills to repair and reduce racking risk?

In house repair skills means you can minimise production downtime and your repair costs long term, by addressing damage when it happens. Provide the skills and knowledge required for your team to safely carry out repairs on damaged racking systems with confidence, by trainers who are all highly experienced ex installers.

Book a course to secure your organisation against safety and operational risks

**ASK US
TO QUOTE**



RACKING-UK

Storage & Workplace Equipment

*...there is no space too big
too small or too awkward*

 essexmezz@icloud.com

 www.racking-uk.com

 **01621 786 630**

 **07831 653839**